

Hangzhou Hikrobot Technology Co.,Ltd.

# GigE Area Scan Camera

User Manual

**HIKROBOT**

## Legal Information

©2023 Hangzhou Hikrobot Co., Ltd. All rights reserved.

### About this Manual

The document includes instructions for using and managing the product. Pictures, charts, images and all other information hereinafter are for description and explanation only. The information contained in the document is subject to change, without notice, due to firmware updates or other reasons. Please find the latest version in the company website (<https://en.hikrobotics.com/>). Unless otherwise agreed, Hangzhou Hikrobot Co., Ltd. or its affiliates (hereinafter referred to as "Hikrobot") makes no warranties, express or implied. Please use the Document with the guidance and assistance of professionals trained in supporting the Product.

### Acknowledgment of Intellectual Property Rights

Hikrobot owns the copyrights and/or patents related to the technology embodied in the Products described in this Document, which may include licenses obtained from third parties. Any part of the Document, including text, pictures, graphics, etc., belongs to Hikrobot. No part of this Document may be excerpted, copied, translated, or modified in whole or in part by any means without written permission.

**HIKROBOT** and other Hikrobot's trademarks and logos are the properties of Hikrobot in various jurisdictions. Other trademarks and logos mentioned are the properties of their respective owners.

### Disclaimer

TO THE MAXIMUM EXTENT PERMITTED BY APPLICABLE LAW, THIS MANUAL AND THE PRODUCT DESCRIBED, WITH ITS HARDWARE, SOFTWARE AND FIRMWARE, ARE PROVIDED "AS IS" AND "WITH ALL FAULTS AND ERRORS". HIKROBOT MAKES NO WARRANTIES, EXPRESS OR IMPLIED, INCLUDING WITHOUT LIMITATION, MERCHANTABILITY, SATISFACTORY QUALITY, OR FITNESS FOR A PARTICULAR PURPOSE. THE USE OF THE PRODUCT BY YOU IS AT YOUR OWN RISK. IN NO EVENT WILL HIKROBOT BE LIABLE TO YOU FOR ANY SPECIAL, CONSEQUENTIAL, INCIDENTAL, OR INDIRECT DAMAGES, INCLUDING, AMONG OTHERS, DAMAGES FOR LOSS OF BUSINESS PROFITS, BUSINESS INTERRUPTION, OR LOSS OF DATA, CORRUPTION OF SYSTEMS, OR LOSS OF DOCUMENTATION, WHETHER BASED ON BREACH OF CONTRACT, TORT (INCLUDING NEGLIGENCE), PRODUCT LIABILITY, OR OTHERWISE, IN CONNECTION WITH THE USE OF THE PRODUCT, EVEN IF HIKROBOT HAS BEEN ADVISED OF THE POSSIBILITY OF SUCH DAMAGES OR LOSS.

YOU ACKNOWLEDGE THAT THE NATURE OF INTERNET PROVIDES FOR INHERENT SECURITY RISKS, AND HIKROBOT SHALL NOT TAKE ANY RESPONSIBILITIES FOR ABNORMAL OPERATION, PRIVACY LEAKAGE OR OTHER DAMAGES RESULTING FROM CYBER-ATTACK, HACKER ATTACK, VIRUS INFECTION, OR OTHER INTERNET SECURITY RISKS; HOWEVER, HIKROBOT WILL PROVIDE TIMELY TECHNICAL SUPPORT IF REQUIRED.

YOU AGREE TO USE THIS PRODUCT IN COMPLIANCE WITH ALL APPLICABLE LAWS, AND

YOU ARE SOLELY RESPONSIBLE FOR ENSURING THAT YOUR USE CONFORMS TO THE APPLICABLE LAW. ESPECIALLY, YOU ARE RESPONSIBLE, FOR USING THIS PRODUCT IN A MANNER THAT DOES NOT INFRINGE ON THE RIGHTS OF THIRD PARTIES, INCLUDING WITHOUT LIMITATION, RIGHTS OF PUBLICITY, INTELLECTUAL PROPERTY RIGHTS, OR DATA PROTECTION AND OTHER PRIVACY RIGHTS. YOU SHALL NOT USE THIS PRODUCT FOR ANY PROHIBITED END-USES, INCLUDING THE DEVELOPMENT OR PRODUCTION OF WEAPONS OF MASS DESTRUCTION, THE DEVELOPMENT OR PRODUCTION OF CHEMICAL OR BIOLOGICAL WEAPONS, ANY ACTIVITIES IN THE CONTEXT RELATED TO ANY NUCLEAR EXPLOSIVE OR UNSAFE NUCLEAR FUEL-CYCLE, OR IN SUPPORT OF HUMAN RIGHTS ABUSES.

THE PERFORMANCE DATA IN THIS PUBLICATION IS BASED ON HIKROBOT'S INTERNAL RESEARCH/EVALUATION. ACTUAL DATA MAY VARY DEPENDING ON SPECIFIC CONFIGURATIONS AND OPERATING CONDITIONS AND HIKROBOT SHALL NOT BEAR THE CONSEQUENCES ARISING THEREFROM.

IN THE EVENT OF ANY CONFLICTS BETWEEN THIS MANUAL AND THE APPLICABLE LAW, THE LATTER PREVAILS.

## Regulatory Information

---

### Note

These clauses apply only to the products bearing the corresponding mark or information.

---

### FCC Information

Please take attention that changes or modification not expressly approved by the party responsible for compliance could void the user's authority to operate the equipment.

### FCC Compliance

This equipment has been tested and found to comply with the limits for a Class A digital device, pursuant to part 15 of the FCC Rules. These limits are designed to provide reasonable protection against harmful interference when the equipment is operated in a commercial environment. This equipment generates, uses, and can radiate radio frequency energy and, if not installed and used in accordance with the instruction manual, may cause harmful interference to radio communications. Operation of this equipment in a residential area is likely to cause harmful interference in which case the user will be required to correct the interference at his own expense.

### FCC Conditions

This device complies with part 15 of the FCC Rules. Operation is subject to the following two conditions:

- This device may not cause harmful interference.
- This device must accept any interference received, including interference that may cause undesired operation.

## EU Conformity Statement



This product and - if applicable - the supplied accessories too are marked with "CE" and comply therefore with the applicable harmonized European standards listed under the Directive 2014/30/EU(EMCD), Directive 2001/95/EC(GPSD) and Directive 2011/65/EU(RoHS).



2012/19/EU (WEEE directive): Products marked with this symbol cannot be disposed of as unsorted municipal waste in the European Union. For proper recycling, return this product to your local supplier upon the purchase of equivalent new equipment, or dispose of it at designated collection points. For more information see: <http://www.recyclethis.info>



2006/66/EC (battery directive): This product contains a battery that cannot be disposed of as unsorted municipal waste in the European Union. See the product documentation for specific battery information. The battery is marked with this symbol, which may include lettering to indicate cadmium (Cd), lead (Pb), or mercury (Hg). For proper recycling, return the battery to your supplier or to a designated collection point. For more information see: <http://www.recyclethis.info>

Warning: This is a class A product. In a domestic environment this product may cause radio interference in which case the user may be required to take adequate measures.

## KC Certification

Class A: The device is advised to note that as a seller or a business user (Class A) Devices and intended for use outside the Home area.

A급 기기: 이 기기는 업무용(A급) 전자파적합기기로서 판매자 또는 사용자는 이 점을 주의하시기바라며, 가정 외의 지역에서 사용하는 것을 목적으로 합니다.

## Symbol Conventions

The symbols that may be found in this document are defined as follows.

Symbol	Description
<b>Danger</b>	Indicates a hazard with a high level of risk, which if not avoided, will result in death or serious injury.
<b>Caution</b>	Indicates a potentially hazardous situation which, if not avoided, could result in equipment damage, data loss, performance degradation, or unexpected results.
<b>Note</b>	Provides additional information to emphasize or supplement important points of the main text.

## Available Model

This manual is applicable to the GigE area scan camera.

## Contact Information

Hangzhou Hikrobot Co., Ltd.

E-mail: [global.support@hikrobotics.com](mailto:global.support@hikrobotics.com)

Website: <https://en.hikrobotics.com/>

# Contents

<b>Chapter 1 Safety Instruction .....</b>	<b>1</b>
1.1 Safety Claim .....	1
1.2 Safety Instruction .....	1
1.3 Electromagnetic Interference Prevention.....	3
<b>Chapter 2 Cleaning Instruction.....</b>	<b>4</b>
2.1 Device and Lens Cleaning .....	4
2.1.1 Rubber Dust Air Blower .....	4
2.1.2 Mirror Brush Cleaning .....	5
2.1.3 Contact Cleaning.....	5
2.1.4 Lens Cleaning Paper.....	6
2.2 Device Housing Cleaning .....	7
<b>Chapter 3 Overview.....</b>	<b>8</b>
3.1 Introduction .....	8
3.2 Key Feature.....	8
3.3 Operating Principle.....	8
<b>Chapter 4 Device Hardware.....</b>	<b>10</b>
4.1 Appearance.....	10
4.2 Power and I/O Connector .....	14
4.2.1 6-Pin P7 Connector .....	14
4.2.2 12-Pin P10 Connector.....	15
4.3 Indicator.....	16
4.4 Lens .....	16
4.4.1 Lens Mount .....	16
4.4.2 Lens Selection .....	16
4.5 Cable.....	17
4.5.1 Cable Selection.....	17
4.5.2 Wiring Principle .....	17
<b>Chapter 5 Power Supply and Heat Dissipation.....</b>	<b>21</b>
5.1 Device Power Supply .....	21

5.1.1 PoE Power Supply .....	21
5.1.2 DC Power Supply .....	21
5.2 Heat Dissipation .....	21
5.2.1 Temperature Parameter .....	22
5.2.2 Heat Dissipation Measures .....	23
5.2.3 Low Heat Conduction Material .....	25
<b>Chapter 6 Quick Start Guide.....</b>	<b>26</b>
6.1 Install Device .....	27
6.1.1 Installation Preparation .....	27
6.1.2 Install .....	27
6.2 Install Client Software .....	28
6.3 Set PC Environment .....	30
6.3.1 Turn off Firewall .....	30
6.3.2 Set PC Network .....	31
6.4 Set Device Network .....	33
6.5 Basic Operation .....	34
<b>Chapter 7 I/O Electrical Features and Wiring .....</b>	<b>36</b>
7.1 I/O Electrical Features .....	36
7.1.1 Electrical Features of Input Signal .....	36
7.1.2 Electrical Features of Output Signal .....	37
7.1.3 Electrical Features of Bi-Directional Signal.....	38
7.1.4 Factors Affecting Transmission Delay of I/O Lines .....	41
7.2 I/O Wiring.....	42
7.2.1 Input Signal Wiring .....	42
7.2.2 Output Signal Wiring .....	43
7.2.3 Bi-Directional Signal Wiring .....	44
<b>Chapter 8 Trigger Input and Output.....</b>	<b>48</b>
8.1 Trigger Input.....	48
8.1.1 Set Trigger Mode.....	48
8.1.2 Set Trigger Source .....	49
8.1.3 Set Trigger Related Parameters .....	54
8.2 Trigger Output.....	60

8.2.1 Enable Line Inverter .....	61
8.2.2 Enable Strobe Signal .....	61
<b>Chapter 9 Image Acquisition .....</b>	<b>67</b>
9.1 Global Shutter and Rolling Shutter .....	67
9.1.1 Global Shutter .....	67
9.1.2 Rolling Shutter .....	67
9.2 Set Acquisition Mode .....	69
9.3 Non-Overlap Exposure and Overlap Exposure .....	70
9.3.1 Non-Overlap Exposure .....	71
9.3.2 Overlap Exposure .....	71
<b>Chapter 10 Image Transmission .....</b>	<b>73</b>
10.1 Set Frame Rate .....	73
10.2 Set Full Frame Transmission .....	74
10.3 Set Packet Size .....	75
10.4 Set Reserved Bandwidth .....	76
10.5 Set Packet Interval .....	76
10.6 Set Pause Frame .....	77
<b>Chapter 11 Basic Functions .....</b>	<b>78</b>
11.1 View Resolution and ROI .....	78
11.2 Set Image Reverse .....	79
11.3 Set Pixel Format .....	80
11.4 Set Image Compression Mode .....	83
11.5 Set Test Pattern .....	84
11.6 Set Binning .....	86
11.7 Set Decimation .....	88
11.8 Set Exposure Mode .....	89
11.8.1 Set Ultrashort Mode .....	89
11.8.2 Set Standard Mode .....	90
11.9 Set Brightness .....	90
11.10 Set Sharpness .....	92
11.11 Set Contrast Ratio .....	92
11.12 Set White Balance .....	93



<b>11.13 Set Sequencer Control and HDR</b> .....	94
11.13.1 Set Sequencer .....	95
11.13.2 Set HDR .....	97
<b>11.14 Set Gain</b> .....	98
11.14.1 Set Analog Gain .....	98
11.14.2 Set Digital Gain .....	99
<b>11.15 User Set Customization</b> .....	100
11.15.1 Save User Set .....	100
11.15.2 Load User Set .....	101
11.15.3 Set User Default .....	102
<b>Chapter 12 Advanced Functions</b> .....	<b>103</b>
12.1 Set Black Level .....	103
12.2 Set Gamma Correction .....	103
12.3 Set Digital Noise Reduction .....	106
12.4 Set AOI .....	106
12.5 Set Color Transformation Control .....	107
12.6 Set Hue .....	108
12.7 Set Saturation .....	110
12.8 Set Super Palette Control .....	111
12.9 Set Sensor Mode .....	112
12.10 Set WDR Mode .....	112
12.11 Set Shading Correction .....	113
12.11.1 LSC Correction .....	113
12.11.2 Other Corrections .....	115
12.12 Set Channel Correct Mode .....	116
12.13 Set LUT .....	116
12.14 Event Control .....	117
12.15 Transfer Control .....	119
12.15.1 User Controlled Transfer Control .....	119
12.15.2 Basic Transfer Control .....	120
12.16 Set Cooling Fan .....	121

<b>Chapter 13 Other Functions .....</b>	<b>122</b>
13.1 Device Control.....	122
13.2 Transport Layer Control .....	124
13.3 Embed Information into Image .....	128
13.3.1 Watermark Settings.....	129
13.3.2 Chunk Settings.....	131
13.4 Set Action Command.....	132
13.5 File Access Control .....	134
13.6 Multicast Function .....	135
13.6.1 Set Multicast (Available Status) .....	135
13.6.2 Set Multicast (Connected Status).....	136
13.7 Update Firmware .....	137
13.8 Encrypt Device via Dongle Tool .....	138
<b>Chapter 14 FAQ (Frequently Asked Question) .....</b>	<b>140</b>
14.1 Why the client software cannot list devices? .....	140
14.2 Why device connection fails after the device is listed in the client software? .	140
14.3 Why the live view is black? .....	140
14.4 Why the device cannot be triggered although the live view is normal?.....	141
14.5 Why the network changes from GigE Ethernet to Fast Ethernet? .....	141
14.6 Why the device is disconnected during operation?.....	141
<b>Chapter 15 Revision History .....</b>	<b>142</b>
<b>Appendix A Device Parameter Index.....</b>	<b>144</b>
A.1 Device Control.....	144
A.2 Image Format Control.....	146
A.3 Acquisition Control .....	147
A.4 Analog Control .....	148
A.5 Color Transformation Control .....	149
A.6 Super Palette Control .....	150
A.7 LUT Control .....	150
A.8 Shading Correction .....	150
A.9 Digital IO Control .....	151
A.10 Action Control.....	151

<b>A.11 Counter and Timer Control</b> .....	151
<b>A.12 File Access Control</b> .....	152
<b>A.13 Sequencer Control</b> .....	152
<b>A.14 Event Control</b> .....	153
<b>A.15 Chunk Data Control</b> .....	153
<b>A.16 Transport Layer Control</b> .....	153
<b>A.17 Transfer Control</b> .....	155
<b>A.18 User Set Control</b> .....	156

# Chapter 1 Safety Instruction

The safety instructions are intended to ensure that the user can use the device correctly to avoid danger or property loss. Read and follow these safety instructions before installing, operating and maintaining the device.

## 1.1 Safety Claim

- To ensure personal and device safety, when installing, operating, and maintaining the device, follow the signs on the device and all safety instructions described in the manual.
- The note, caution and danger items in the manual do not represent all the safety instructions that should be observed, but only serve as a supplement to all the safety instructions.
- The device should be used in an environment that meets the design specifications, otherwise it may cause malfunctions, and malfunctions or component damage caused by non-compliance with relevant regulations are not within the scope of the device's quality assurance.
- Our company will not bear any legal responsibility for personal safety accidents and property losses caused by abnormal operation of the device.

## 1.2 Safety Instruction

### **Caution:**

- Do not install the device if it is found that the device and accessories are damaged, rusted, water ingress, model mismatch, missing parts, etc., when unpacking.
- Avoid storage and transportation in places such as water splashing and rain, direct sunlight, strong electric fields, strong magnetic fields, and strong vibrations.
- Avoid dropping, smashing or vigorously vibrating the device and its components.
- It is forbidden to install the indoor device in an environment where it may be exposed to water or other liquids. If the device is damp, it may cause fire and electric shock hazard.
- Place the device in a place out of direct sunlight and ventilation, away from heat sources such as heaters and radiators.
- In the use of the device, you must be in strict compliance with the electrical safety regulations of the nation and region.
- Use the power adapter provided by the official manufacturer. The power adapter must meet the Limited Power Source (LPS) requirements. For specific requirements, please refer to the device's technical specifications.
- If the device emits smoke, odor or noise, please turn off the power and unplug the power cord immediately, and contact the dealer or service center in time.

- It is strictly forbidden to touch any terminal of the device when operating it. Otherwise there is a danger of electric shock.
- It is strictly forbidden for non-professional technicians to detect signals during device operation, otherwise it may cause personal injury or device damage.
- It is strictly forbidden to maintain the device is powered on, otherwise there is a danger of electric shock.
- Avoid aiming the lens at strong light (such as lighting, sunlight, or laser beams, etc.), otherwise the image sensor will be damaged.
- If it is necessary to clean the device, use a damp paper towel or a soft clean cloth to moisten a little pure water, gently wipe off the dust, and do not use alcohol-based corrosive solutions. Make sure to power off the device and unplug the power socket when cleaning.
- Keep clean of the device's image acquisition window. It is recommended to use cleaning water to wipe off the dust.
- If the device does not work properly, please contact your dealer or the nearest service center. Never attempt to disassemble the device yourself (we shall not assume any responsibility for problems caused by unauthorized repair or maintenance).
- Caution: If the device has battery, risk of explosion if battery is replaced by an incorrect type. Dispose of used batteries according to the instructions.
- Please dispose of the device in strict accordance with the relevant national or regional regulations and standards to avoid environmental pollution and property damage.

### **Note:**

- Check whether the device's package is in good condition, whether there is damage, intrusion, moisture, deformation, etc. before unpacking.
- Check the surface of the device and accessories for damage, rust, bumps, etc. when unpacking.
- Check whether the quantity and information of the device and accessories are complete after unpacking.
- Store and transport the device according to the storage and transport conditions of the device, and the storage temperature and humidity should meet the requirements.
- It is strictly prohibited to transport the device in combination with items that may affect or damage the device.
- Quality requirements for installation and maintenance personnel:
  - Qualification certificate or working experience in weak current system installation and maintenance, and relevant working experience and qualifications. Besides, the personnel must possess the following knowledge and operation skills.
  - The basic knowledge and operation skills of low voltage wiring and low voltage electronic circuit connection.
  - The ability to comprehend the contents of this manual.
- Please read the manual and safety instructions carefully before installing the device.
- Please install the device strictly according to the installation method in this manual.
- The case of the device may be overheated, and it needs to be powered off for half an hour before it can be touched.

- The device should not be placed with exposed flame sources, such as lighted candles.

### 1.3 Electromagnetic Interference Prevention

- Make sure that the shielding layer of cables is intact and 360° connected to the metal connector when using shielded cables.
- Do not route the device together with other equipment (especially servo motors, high-power devices, etc.), and control the distance between cables to more than 10 cm. Make sure to shield the cables if unavoidable.
- The control cable of the device and the power cable of the industrial light source must be wired separately to avoid bundled wiring.
- The power cable, data cable, signal cable, etc. of the device must be wired separately. Make sure to ground them if the wiring groove is used to separate the wiring and the wiring groove is metal.
- During the wiring process, evaluate the wiring space reasonably, and do not pull the cables hard, so as not to damage the electrical performance of the cables.
- If the device is powered on and off frequently, it is necessary to strengthen the voltage isolation, and consider adding a DC/DC isolation power supply module between the device and the adapter.
- Use the power adapter to supply power to the device separately. If centralized power supply is necessary, make sure to use a DC filter to filter the power supply of the device separately before use.
- The unused cables of the device must be insulated.
- When installing the device, if you cannot ensure that the device itself and all equipment connected to the device are well grounded, you should isolate the device with an insulating bracket.
- To avoid the accumulation of static electricity, ensure that other equipment (such as machines, internal components, etc.) and metal brackets on site are properly grounded.
- Make sure that the connector metal barrier of the device is well connected to the PC and other chassis, and if necessary, copper foil should be used to enhance the grounding effect.
- During the installation and use of the device, high voltage leakage must be avoided.
- Use a figure-eight bundle method if the device cable is too long.
- When connecting the device and metal accessories, they must be connected firmly to maintain good conductivity.
- Use a shielded network cable to connect to the device. If you use a self-made network cable, make sure that the shielding shell at the aviation head is well connected to the aluminum foil or metal braid of the shielding cable.

## Chapter 2 Cleaning Instruction

### 2.1 Device and Lens Cleaning

Four ways are available to clean the device and lens when they have dust or stains.

**Table 2-1 Device and Clean Method**

Equipment Clean Method	Camera	Lens
Rubber Dust Air Blower	Support	Support
Mirror Brush Cleaning	Not Support	Support
Contact Cleaning	Support	Support
Lens Cleaning Paper	Not Support	Support

#### 2.1.1 Rubber Dust Air Blower

You can use a rubber dusk air blower to clean the dust on the surface of the device filter and lens. The specific operation steps are as follows:

##### Steps

1. Blow the rubber dusk air blower downward several times to blow out the dust inside.
2. Hold the device or lens and tilt it down so that the air blower port and the device lens are at an angle of 45°.
3. Blow to clean the dust on the surface of the device filter and lens.



**Figure 2-1 Cleaning by Rubber Dust Air Blower**

## Note

- Do not go too far into the device's lens mount and avoid direct contact with the dust glass when cleaning.
  - It is strictly forbidden to blow the lens directly from the mouth, and avoid spattering saliva particles onto the glass surface, causing serious secondary pollution.
- 

## 2.1.2 Mirror Brush Cleaning

If the dust on the surface of the lens cannot be cleaned by rubber dusk air blower, use a mirror brush to gently remove the dust on the surface of the lens.

---

## Note

Do not touch the bristles directly with your hands.

---

## 2.1.3 Contact Cleaning

For the stubborn stains on device filter or lens surface, such as finger marks, liquid stains, etc., it is recommended to use a fat-free cotton swab or dust-free cloth, with high purity alcohol wipe clean. Take the fat-free cotton swab as an example, the specific operation steps are as follows:

### Steps

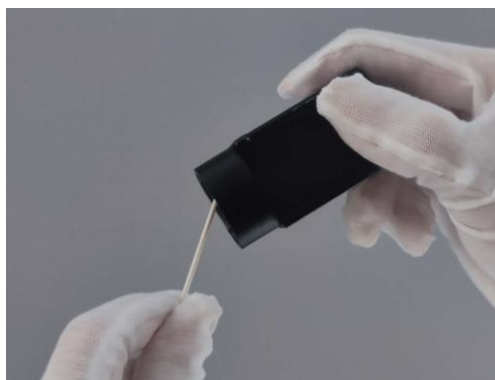
1. Take a clean fat-free cotton swab, dip in proper amount of alcohol or cleaning liquid.
- 

## Note

Do not touch the head of the cotton swab by fingers.

---

2. Tilt the fat-free cotton swab about 60 degrees, resist the device filter or lens surface, clean from left to right, turn cotton swab over one side, and clean again from right to left.
3. Take another fat-free cotton swab that is not stained with alcohol or cleaning liquid and swipe the device filter or lens to absorb the remaining alcohol or cleaning liquid.



**Figure 2-2 Contact Cleaning**



4. Check whether there is still a stain. If the stain changes position, repeat steps above, until the stain is cleaned.

---

### Note

If the stains on the lens cannot be wiped or clean, please clean by using lens cleaning paper. For specific operation steps, please refer to the next section.

---

## 2.1.4 Lens Cleaning Paper

For lens stains that cannot be cleaned by a fat-free cotton swab or dust-free cloth, use lens cleaning paper to clean them.

### **Before You Start**

- Use lens paper purchased from a regular, professional photography store.
- Use freshly opened lens cleaning paper in a wet state.
- Make sure there is no hard dust on the lens.

Tear off the outer package of the lens cleaning paper, fold the pre-moistened paper to a suitable wiping state, and slowly spiral wipe it in the same direction from the center of the lens outward.



**Figure 2-3 Cleaning by Lens Cleaning Paper**

---

### Note

- Do not use hard paper, paper towels or napkins to clean the lens. These products contain scratching wood pulp, which will seriously damage delicate coating on the lens.
  - Do not press the lens surface hard when cleaning it the lens cleaning paper. Otherwise, the fragile coating on the lens surface will be wiped off.
-

## 2.2 Device Housing Cleaning

When cleaning the device, try to clean it in a closed room to avoid a large amount of dust in the environment. The specific operation steps are as follows:

### Steps

1. Disconnect the device's power supply.
2. Take a soft lint-free cloth that will not cause static electricity during cleaning and soak it with a neutral detergent.
3. Wipe the device's housing with a soaked, lint-free cloth as appropriate.
4. Wait for the residual moisture to evaporate after wiping. When the moisture has completely evaporated, you can reconnect the device to the power supply.

---

### Note

Do not use compressed air to accelerate evaporation.

---

## Chapter 3 Overview

### 3.1 Introduction

The GigE area scan camera uses the GigE interface to transmit non-compressed images in real time, and it acquires images and sets parameters via the client software or SDK. The GigE area scan camera is applicable to the automated optical inspection (AOI) for the surface mounted technology and the printed circuit board, electronic semiconductor, factory automation, logistics industry, etc.

### 3.2 Key Feature

- Supports auto and manual adjustment for gain, exposure time and white balance, manual adjustment for Look-Up Table (LUT), Gamma correction, etc.
- Adopts the image interpolation algorithm for the color reproduction.
- Supports the hardware trigger, software trigger, free run, etc.
- Adopts GigE interface and max. transmission distance of 100 meters without relay.
- Compatible with the GigE Vision Protocol, the GenICam Standard, and the third-party software based on the protocol and standard.

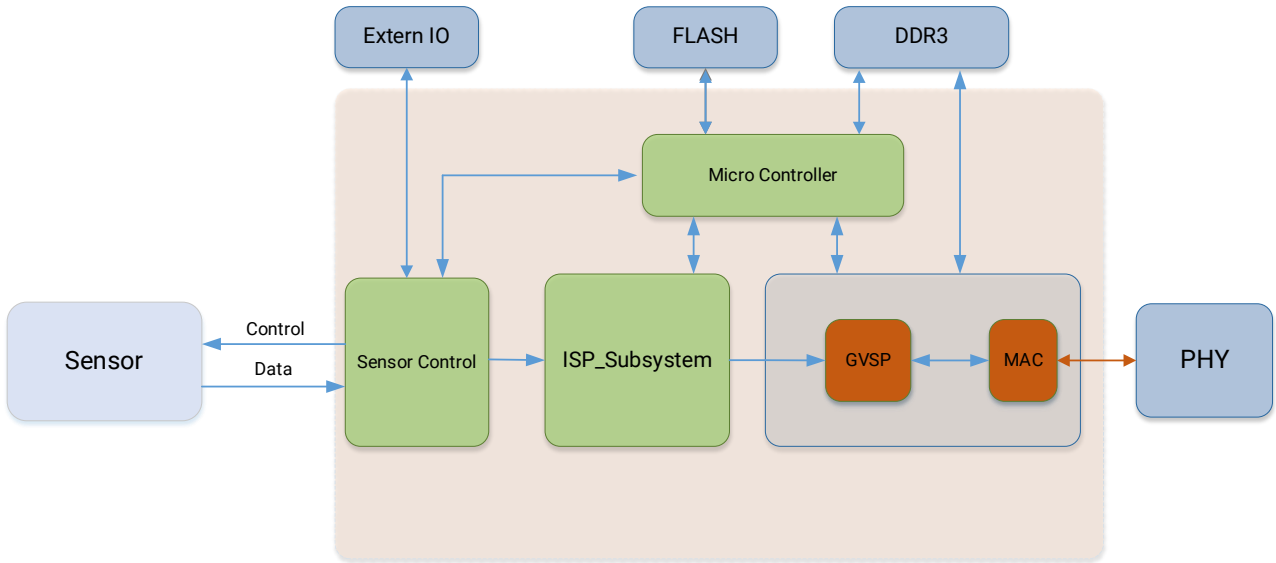
---

 **Note**

- The specific functions may differ by device models.
  - Refer to the device's datasheet for specific parameters.
- 

### 3.3 Operating Principle

The onboard block diagram of the device is shown below. After the image sensor receives the image data, it completes the image data processing through various built-in ISP image-processing algorithms, and finally completes the high-speed transmission of image data through the GigE Vision protocol.



**Figure 3-1 Operating Principle**

## Chapter 4 Device Hardware

### 4.1 Appearance

#### Note

- For specific appearance and dimension, please refer to the device's datasheet for details.
- The appearance is subject to change, and the actual device you purchased shall prevail.
- TEC stands for Thermo-Electric Cooler that is able to keep the device's sensor temperature around environment temperature to ensure the normal operation of the device.

The specific device appearance types are as follows:

- Type I device: It is a device with dimension of 29 mm × 29 mm × 42 mm.
- Type II device: It is a device with dimension of 29 mm × 29 mm × 42 mm, and it can be mounted from four sides.
- Type III device: It is CU series device with dimension of 29 mm × 29 mm × 42 mm.
- Type IV device: It is a device with dimension of 29 mm × 44 mm × 59 mm.
- Type V device: It is an industrial short wave infrared device with C-mount and TEC function.
- Type VI device: It is a device with M58-mount, but has no cooling fan.
- Type VII device: It is a device with F-mount, but has no cooling fan.
- Type VIII device: It is a device with M58-mount, and has cooling fan.
- Type IX device: It is a device with F-mount, and has cooling fan.

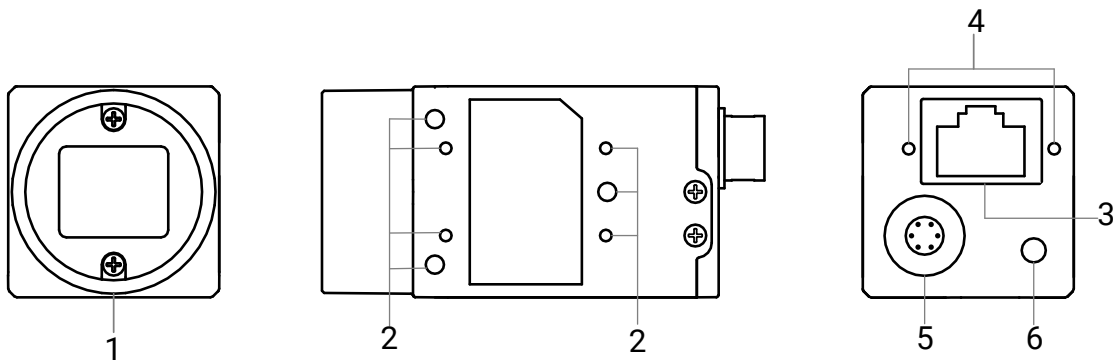


Figure 4-1 Appearance (Type I)

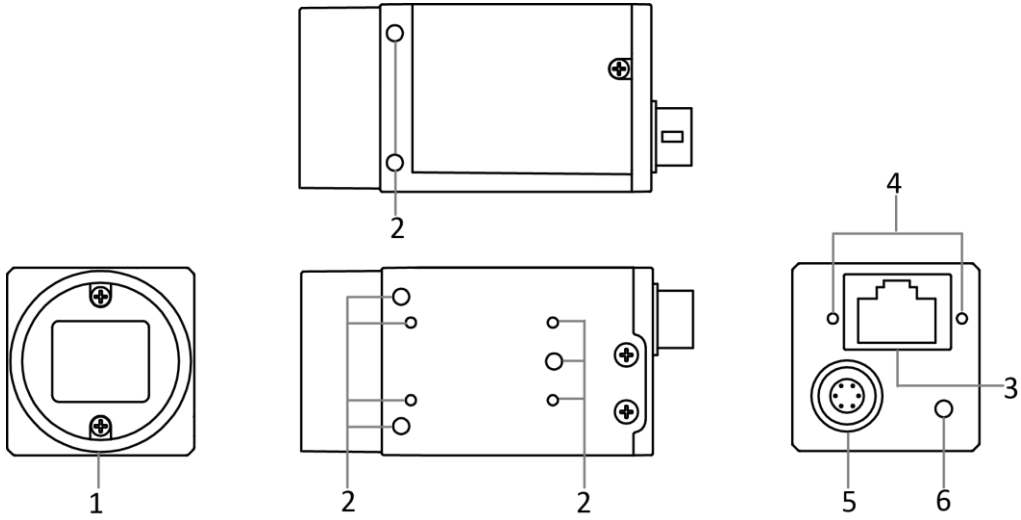


Figure 4-2 Appearance (Type II)

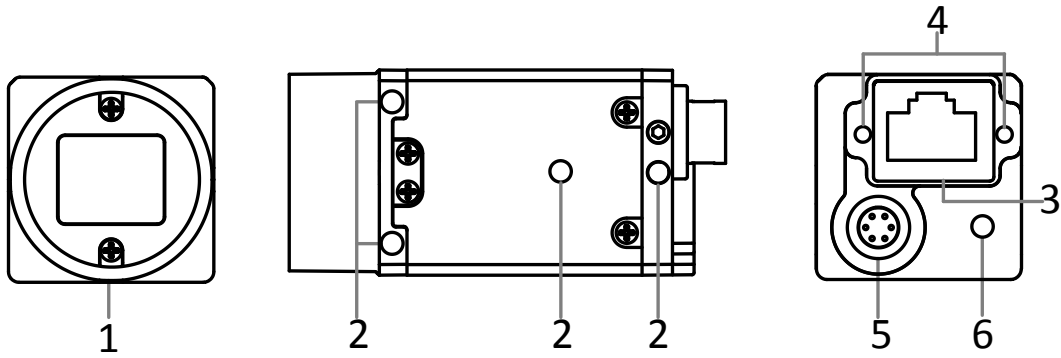


Figure 4-3 Appearance (Type III)

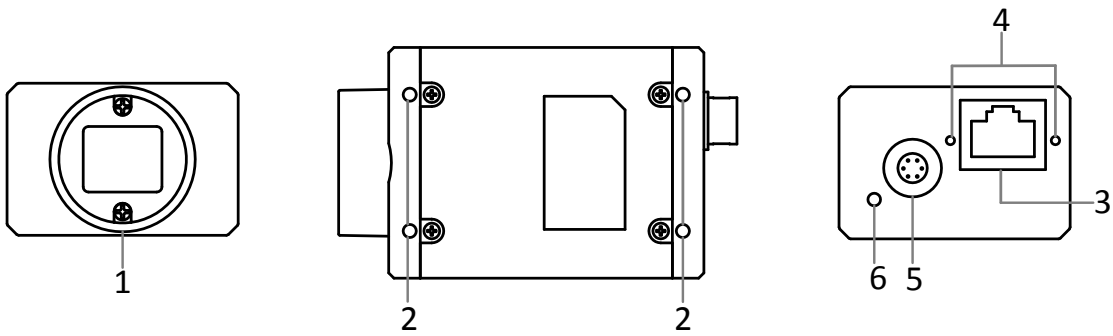
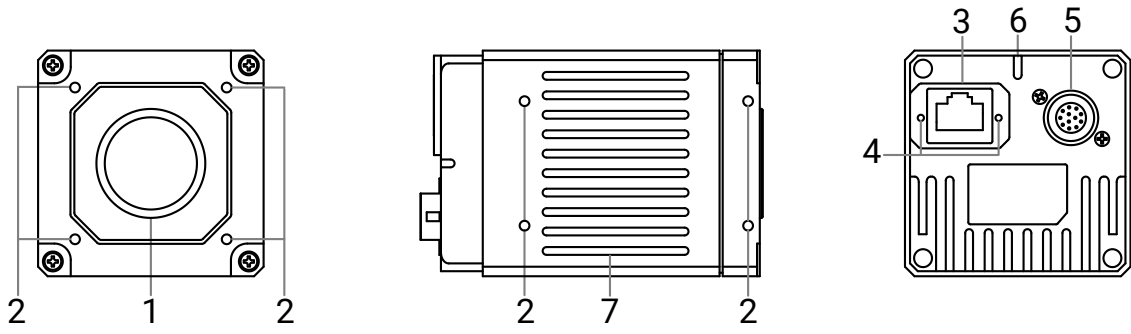
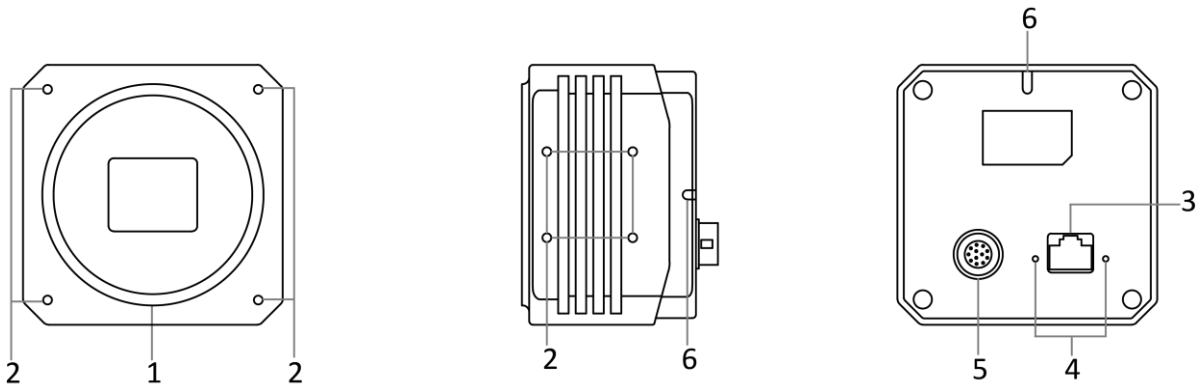


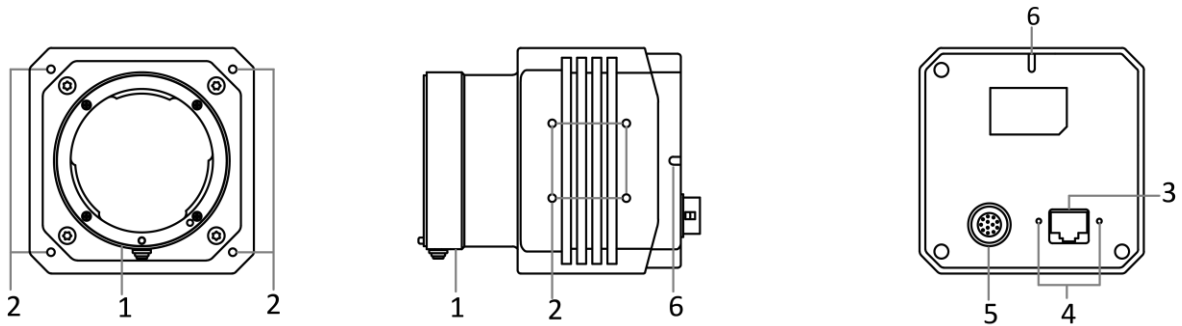
Figure 4-4 Appearance (Type IV)



**Figure 4-5 Appearance (Type V)**



**Figure 4-6 Appearance (Type VI)**



**Figure 4-7 Appearance (Type VII)**

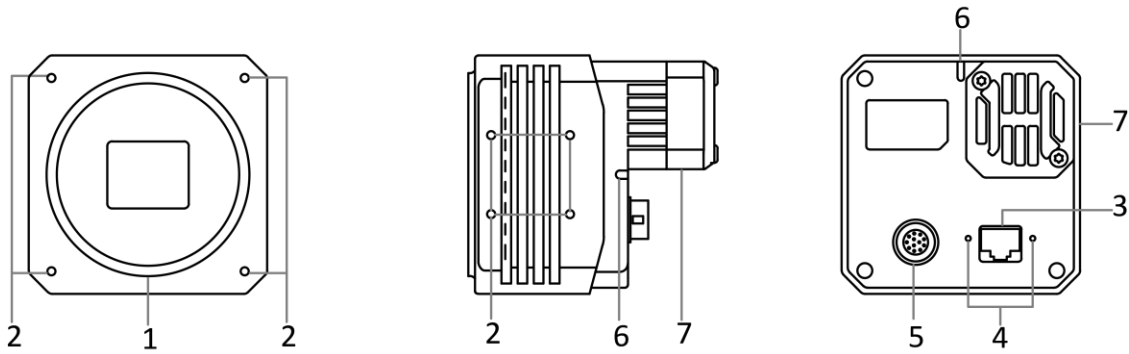


Figure 4-8 Appearance (Type VIII)

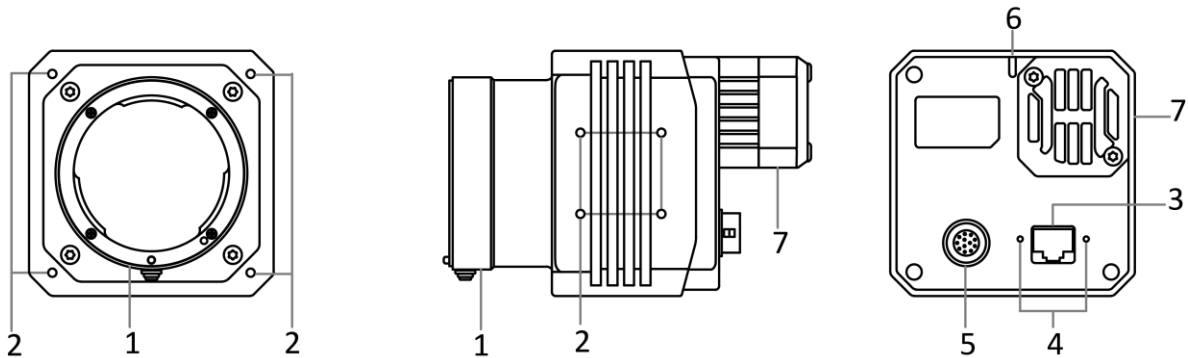


Figure 4-9 Appearance (Type IX)

Table 4-1 Component Description

No.	Component	Description
1	Lens Mount	It is used to install the lens. Refer to the device's datasheet for specific lens mount information.
2	Screw Hole	It is used to fix the device to the installation position. Refer to the device's datasheet for specific screw information.
3	GigE Interface	It refers to the GigE interface for transmitting data.
4	Screw Hole of GigE Interface	It refers to the M2 screw hole for fixing the network cable.
5	Power and I/O Connector	It provides power supply, input/output signal and serial port function.
6	LED Indicator	It indicates the device's status.
7	Cooling Fan or TEC	It is used to cool the device to ensure its normal operation.



## 4.2 Power and I/O Connector

The device has a 6-pin P7 connector or 12-pin P10 connector as the power and I/O connector that provides power supply, input/output signal and serial port function.

### 4.2.1 6-Pin P7 Connector

The 6-pin P7 connector is applicable to type I, type II, type III, and type IV devices.

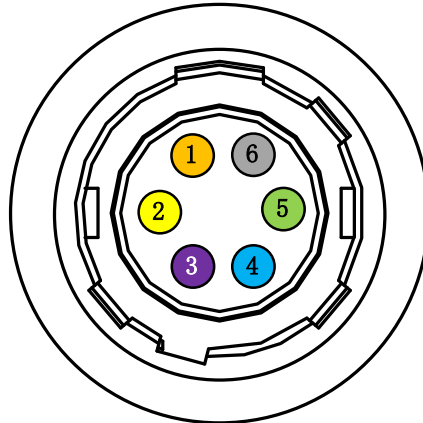


Figure 4-10 6-Pin P7 Connector

#### Note

- Refer to the table below and the label attached to the power and I/O cable to wire the device.
- The wire cores shown in figure 4-10 and table 4-2 are only the wire sequence and the corresponding wire core color of the cables sold by our company. If the cables are not purchased from our company, please refer to the actual wire sequence and the corresponding wire core color.

Table 4-2 Pin Definitions of 6-Pin P7 Connector

No.	Color	Signal	I/O Signal Source	Description
1	Orange	DC_PWR	--	Device's power supply
2	Yellow	OPTO_IN	Line 0+	Opto-isolated input
3	Purple	GPIO	Line 2+	Can be configured as input or output
4	Blue	OPTO_OUT	Line 1+	Opto-isolated output
5	Green	OPTO_GND	Line 0-/1-	Opto-isolated signal ground
6	Gray	GND	Line 2-	Device's power supply ground

## 4.2.2 12-Pin P10 Connector

The 12-pin P10 connector is applicable to other types of devices, as shown below.

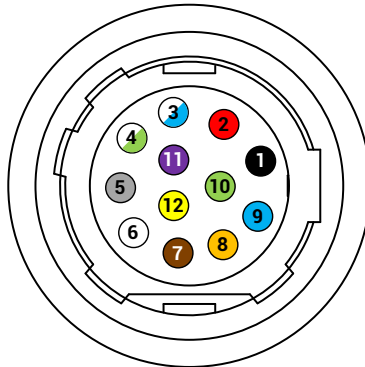


Figure 4-11 12-Pin P10 Connector

### Note

- Refer to the table below and the label attached to the power and I/O cable to wire the device.
- The wire cores shown in figure 4-11 and table 4-3 are only the wire sequence and the corresponding wire core color of the cables sold by our company. If the cables are not purchased from our company, please refer to the actual wire sequence and the corresponding wire core color.

Table 4-3 Pin Definitions of 12-Pin P10 Connector

No.	Color	Signal	I/O Signal Source	Description
1	Black	GND	Line 2-	Device power supply ground
2	Red	DC_PWR	--	Device power supply
3	White/Blue	DC_PWR	--	Device power supply
4	White/Green	OPT_IN-	Line 0-	Opto-isolated input signal ground
5	Gray	OPT_OUT-	Line 1-	Opto-isolated output signal ground
6	White	GND	--	Device power supply ground
7	Brown	GND	--	Device power supply ground
8	Orange	232_RXD	--	RS-232 receives
9	Blue	232_TXD	--	RS-232 transmits
10	Green	GPIO2	Line 2+	Input or output
11	Purple	OPT_OUT+	Line 1+	Opto-isolated output
12	Yellow	OPT_IN+	Line 0+	Opto-isolated input

## 4.3 Indicator

The device's indicator is used to indicate the operation status of the device.

### Note

- The indicator status may differ by device models, and actual devices you purchased shall prevail.
- When the indicator is lit up, flashing rapidly, flashing slowly, or flashing very slowly, its unlit interval is 5 sec, 0.2 sec, 1 sec, and 2 sec respectively.
- The indicator sometimes may show a purple color when red and blue colors flashing at the same time.

**Table 4-4 Indicator Description**

No.	Indicator Color	Status	Device Status Description
1	Red	Flashing very slowly	The device's wiring exception occurs.
2	Red	Solid	The device exception occurs.
3	Blue	Flashing slowly	The device is acquiring images in trigger mode.
4	Blue	Flashing rapidly	The device is acquiring images normally.
5	Blue	Solid	The device is in an idle status.
6	Red and blue	Flash alternatively	The function of finding me is executed, or the firmware is updating.

## 4.4 Lens

### 4.4.1 Lens Mount

The device supports standard C-mount, M58-mount and F-mount lenses. The thread depth of C-mount lens is not less than 7 mm, and that of M58-mount lens is not less than 5 mm.

### 4.4.2 Lens Selection

In order to meet the image acquisition needs of industrial cameras, our company provides a variety of lenses with high performance, high definition, low distortion rate and other features. You should consider following factors when selecting a lens:

- Lens mount: The device supports standard C-mount, M58-mount and F-mount lenses. When selecting lens, select lens with the same mount. When the mount of the device and the lens are different, part of the lens mounts may be switched using corresponding lens adapter.

- Flange focus length: The flange focus length of different lenses is varied. It is necessary to select the lens with the matched flange focus length when selecting the lens.
- Sensor size: Make sure that the target surface of the lens is larger than or equal to the size of the device's sensor size.
- Resolution: It represents the ability of the lens to record the details of an object. It is generally measured in the number of line pairs that can be distinguished per millimeter: line pairs/millimeter (lp/mm). The higher the resolution of the lens, the clearer the image. Make sure that the accuracy required by the system is less than the resolution of the lens when selecting the lens.
- Working distance: The distance from the first working surface of the lens to the measured object. Make sure that the working distance is greater than the minimum object distance of the lens when selecting a lens.
- Focal length: The distance from the center point of the lens to the clear image formed on the focal plane. The smaller the focal length value is, the larger the field of view of the image captured by the digital camera is. According to the focal length of the lens, the appropriate working distance can be set up, or the appropriate lens can be selected according to the requirements of the working distance.

---

### Note

In order to better provide a suitable lens model, you can go to the official website of our company (<https://en.hikrobotics.com/>): **Products** → **Lens** → **Lens Selector** to enter your application parameters, and you will find a suitable lens model. If you have any problems, please contact our technical support.

---

## 4.5 Cable

### 4.5.1 Cable Selection

According to the cable performance, it can be divided into standard, flexible, high flexible and super flexible cables. You need to select cables according to different scenarios.

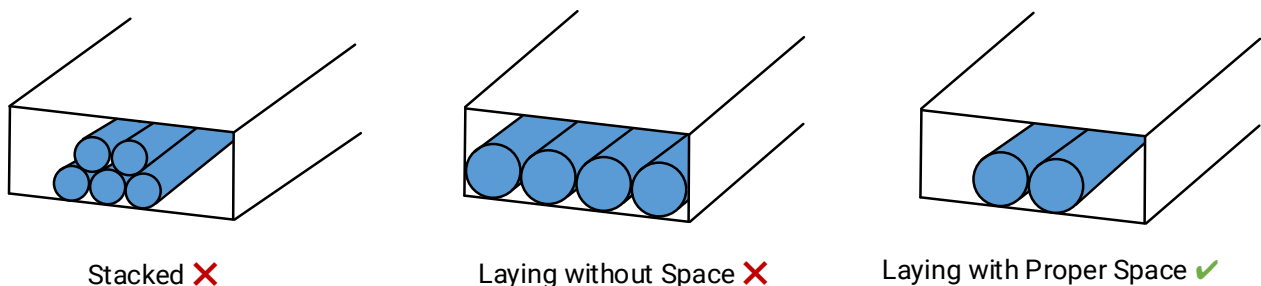
- Standard cable: It is applicable to static scenario only.
- Flexible cable: It can withstand 100000 times of drag chain or bending movement.
- High flexible cable: It can withstand 5 million times of drag chain movement.
- Super flexible cable: It can withstand 10 million times of drag chain movement, 3 million times of bending movement or 5 million times of twisting movement.

### 4.5.2 Wiring Principle

Regarding the power and I/O cable and network cable, attention should be paid to the application requirements of scenarios such as high-frequency communication and high-frequency motion. In such scenarios, if the cables are arranged in an inappropriate manner, various problems may be caused in use, such as cable skin wear, internal

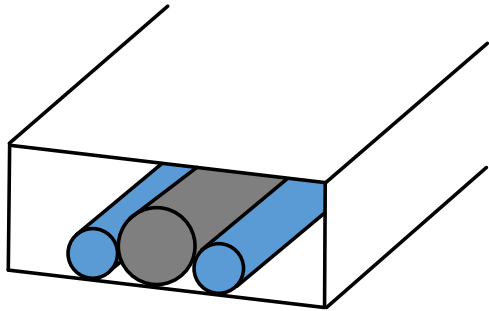
conductor breakage, and device packet loss. Based on the above situation, this section introduces the basic wiring principles and precautions of sports cables to help you install and use related products correctly and improve the overall healthy operating life of the system.

- The minimum bending radius of the chain rail during wiring should be controlled at more than 10 to 12 times the wire diameter (the larger the bending radius, the longer the cable movement life).
- Make sure that the cable does not spin in the chain rail, and the cable should be spread horizontally along the chain rail.
- If the cable is laid too tightly, the cable sheath and the chain rail will produce friction during the movement, which will cause the sheath to wear. Therefore, in the wiring process, the laying tension on the cable should be avoided. If the cable is fixed at the moving part of the chain rail, stress concentration will occur at the fixed position during the movement. Therefore, both ends of the cable can be fixed, but not at the middle moving section.
- Multiple cables may interfere with each other when moving in the chain rail. At this time, the chain rail with sufficient width should be selected to ensure that there is still a certain space after the cables are laid horizontally. The use of spacers is also an effective way to avoid interference. Note that there should also be at least 2 mm clearance between the spacer and the cable. Do not drain cables without spacers. Please keep the space factor occupied by the cable after laying within 30%, as shown below.

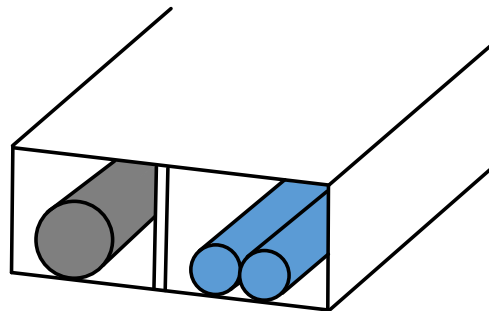


**Figure 4-12 Cable Laying**

In the same chain rail, if there are cables with different thicknesses and diameters, the cables with small outer diameter are easily squeezed to the bottom by the cables with large outer diameter. In this case, use spacers for classification and isolation, as shown below.



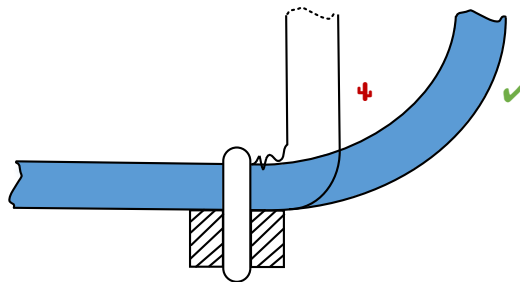
Laying Side by Side of Cables with Different Diameter ❌



Isolate Cables with Different Diameter via Spacer ✅

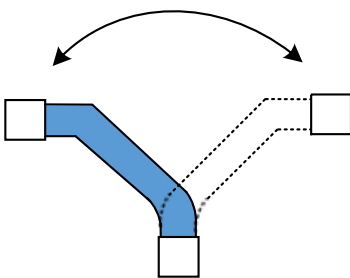
**Figure 4-13 Isolated via Spacer**

- If the wiring is in the same track as the hard object such as the air pipe, use a spacer to isolate it.
- If the chain rail is damaged, replace the chain rail and cable at the same time, because the damaged chain rail may aggravate the damage to the cable.
- Do not bend the cable vertically on the fixed point.

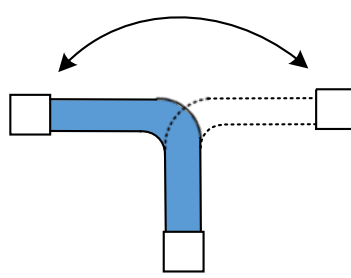


**Figure 4-14 Vertically Bended Prohibited**

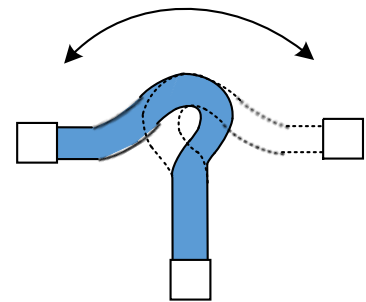
- Make sure to reserve a suitable bending length for the cable.



Too Short Bending Length ❌



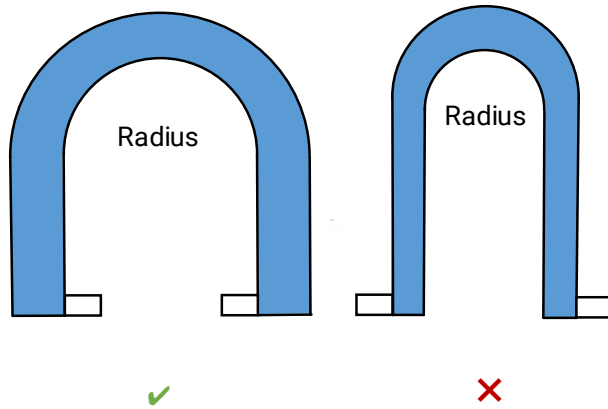
Suitable Bending Length ✅



Too Long Bending Length ❌

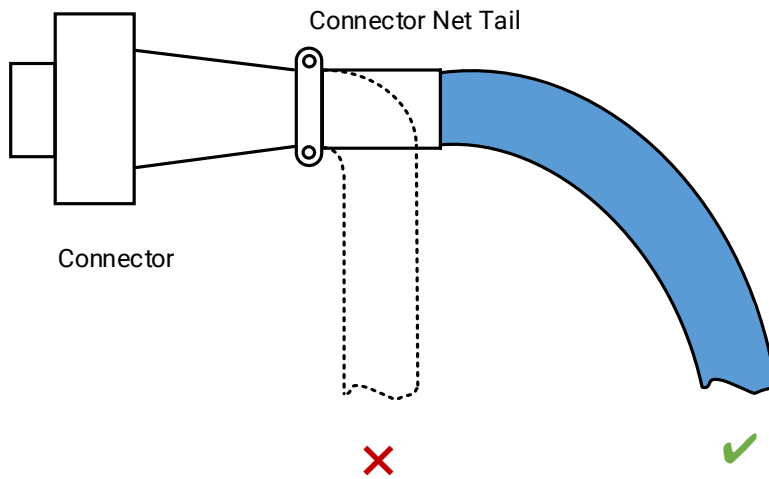
**Figure 4-15 Suitable Bending Length**

- Please keep a sufficient bending radius.



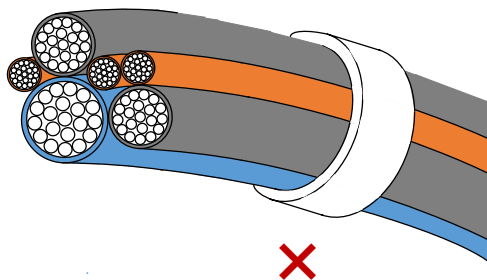
**Figure 4-16 Sufficient Bending Radius**

- When assembling the connector, please fix it on the connector net tail instead of the cable body.



**Figure 4-17 Assemble Connector**

- Do not bind cables of different diameters together.



**Figure 4-18 Improper Binding**

## Chapter 5 Power Supply and Heat Dissipation

### 5.1 Device Power Supply

The device provides two ways of power supply, including PoE and power supply via external DC power supply.

When the external DC power supply and PoE power supply exist at the same time, the external DC power supply preferentially supplies power to the device. If the external DC power supply is unplugged at this time, the device will switch to PoE power supply, and it is possible to restart the device.

#### 5.1.1 PoE Power Supply

If the device supports Power over Ethernet (PoE) power supply, the network cable can be inserted into the RJ45 port. Use a PSE (Power Sourcing Equipment) that complies with the IEEE 802.3af standard and the IEEE 802.3at standard to power the device.

#### 5.1.2 DC Power Supply

Connect the external DC power supply to the I/O connector through the I/O cable to power the device. Refer to the device's label for the specific voltage range of power supply.

---

#### Note

- Using a DC power supply that exceeds the specified voltage range may cause damage or abnormal operation of the device.
  - Inserting a connector that does not match the I/O connector may cause damage or abnormal operation of the device.
  - Do not short-circuit the power supply and ground.
- 

### 5.2 Heat Dissipation

The device contains photosensitive components, if the device's temperature rises, and it will have a certain impact on the quality of the acquired image. Based on the above situation, this section will introduce the temperature parameters and installation suggestions to achieve better heat dissipation effect and improve the image quality and reliability of the device.



## 5.2.1 Temperature Parameter

### Working Temperature

The temperature of the key components of industrial cameras is a key factor affecting image quality, operation stability and long-term reliability. The upper limit of the working environment temperature in the specification of the industrial camera refers to the maximum ambient temperature that the device can meet without any additional heat dissipation measures. Running within the working temperature can meet the temperature requirements on the electronic components and ensure the reliable operation of the device.

The monitoring point of the working environment temperature of the device is 80 mm away from the main housing of the device, as shown below. In the space where the device and the temperature measuring point are located, there is no object in the middle and the temperature distribution is uniform. If the on-site installation environment can add some heat dissipation measures, the temperature of electronic components can be reduced, and the image quality and reliability of the device can be further improved.

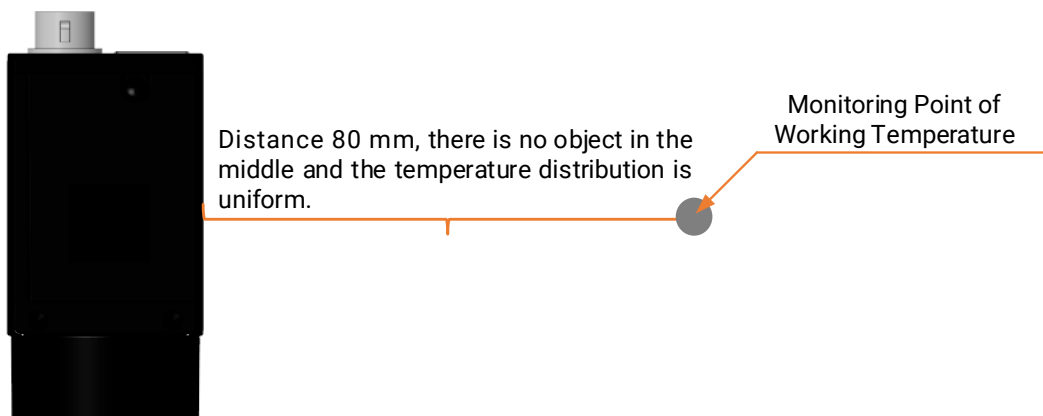


Figure 5-1 Monitoring Point of Working Temperature

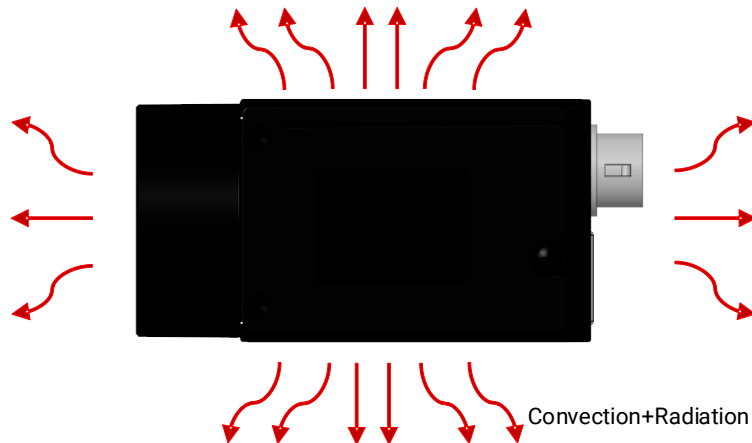
### Housing Temperature

After the heat generated by the electronic components is conducted to the device's housing, if the device does not have any additional heat dissipation measures, the heat is dissipated to the external environment in the form of convection and radiation through the device's housing.

The temperature of the device's housing will gradually rise during the heat dissipation process, and when the thermal equilibrium state is finally reached, the temperature tends to be stable. Therefore, we often feel that the device's housing has a certain temperature, or feel hot, which is a normal phenomenon of device heat dissipation.

Some components inside the device have done heat conduction measures to guide the heat to the housing to ensure that the temperature of the components meets the

specification requirements, which also leads to a higher local temperature of the housing. Device's housing temperature is affected by power consumption, housing size, ambient temperature, and additional heat dissipation measures. Without additional heat dissipation measures, the temperature of the housing is the highest at this time. If some additional heat dissipation measures are added during field installation, the heat is dissipated to the external environment in the form of convection and radiation through the device's housing.



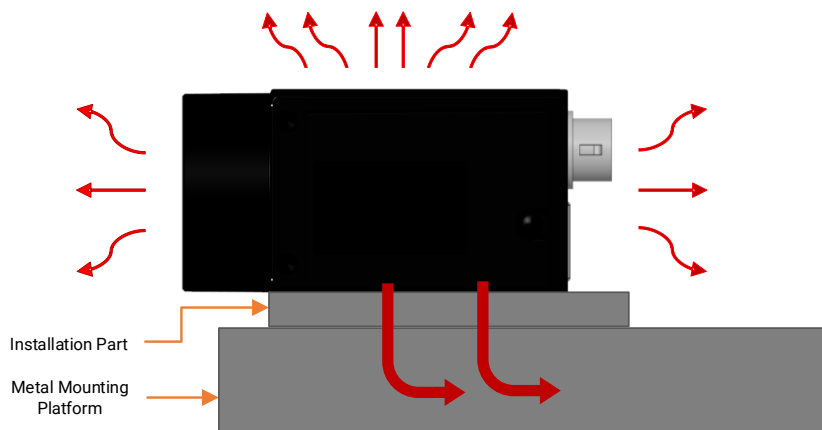
**Figure 5-2 Housing Temperature**

## 5.2.2 Heat Dissipation Measures

### Heat Dissipation via Installation Part

Since most industrial cameras are fixed by the installation part, most of the heat can be guided to the metal mounting platform through the installation part during field installation, so as to dissipate the heat and greatly improve the heat dissipation efficiency of the device.

The heat discharged through the installation part depends on the heat conduction of the installation part itself and the installation method.



**Figure 5-3 Heat Dissipation via Installation Part**

- **Installation Part Material**

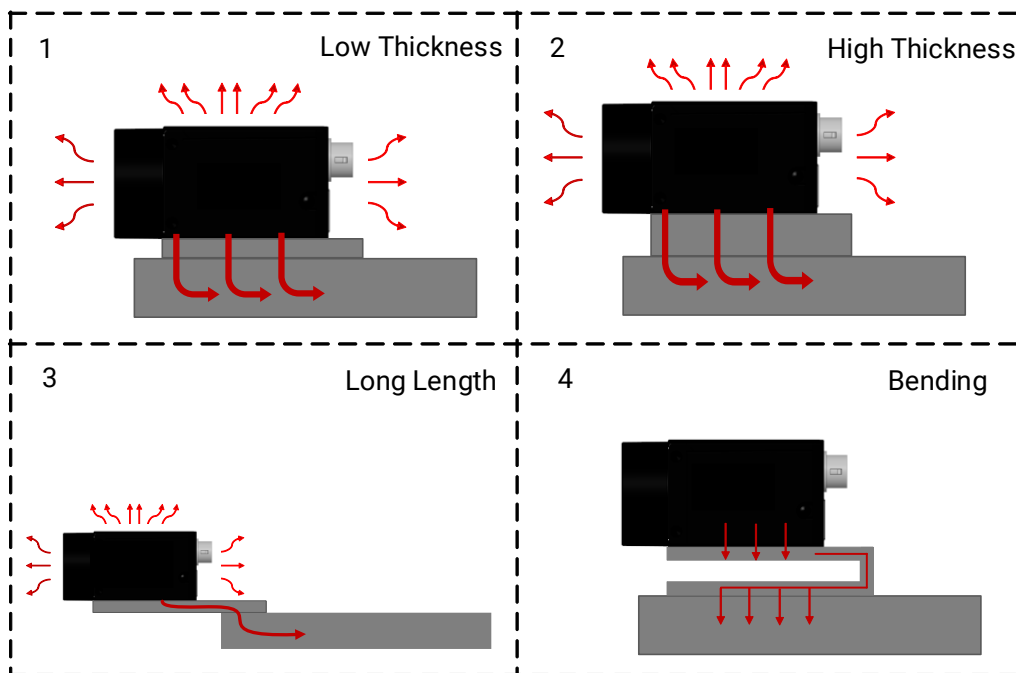
- Use materials with high heat conduction, such as aluminum and copper, which can quickly transfer heat away.
- At the same time, it is best to fix the installation part on the mounting platform of metal material to conduct heat to the metal parts and dissipate it.
- Minimize the use of materials with low heat conduction, such as plastic and rubber.

- **Heat Conduction Path**

- The heat conduction path of the installation part should be as short as possible to improve the heat conduction efficiency.
- The thickness, length, and bending of the installation part will affect the heat conduction path distance of the device.

As shown in the installation method 1 and 2 in figure below, the thickness of the installation part should be reduced as much as possible to shorten the heat conduction path from the device to the metal mounting platform via the installation part.

As shown in the installation method 3 and 4 in figure below, the extension of the length of the installation part and the use of bent metal will lead to the lengthening of the heat conduction path of the device.



**Figure 5-4 Heat Conduction Path of Different Installation Methods**

- **Installation Part Section**

The cross section area along the heat conduction direction should be as large as possible, so that the heat conduction resistance can be reduced. For some installation parts have to use extended or bent metal (as shown in installation methods 3 and 4 in figure above), the thickness of the sheet metal needs to be increased as much as possible to increase the cross section of the device heat conduction path and strengthen the heat conduction.

- **Contact Area**

Surface contact should be used between the device, installation parts and the mounting platform, and the contact area between installation surfaces should be increased as much as possible to improve the heat dissipation of the device. The flatness of the installation part should be within 0.1 mm, in case the actual contact surface is not completely close, affecting the heat dissipation effect.

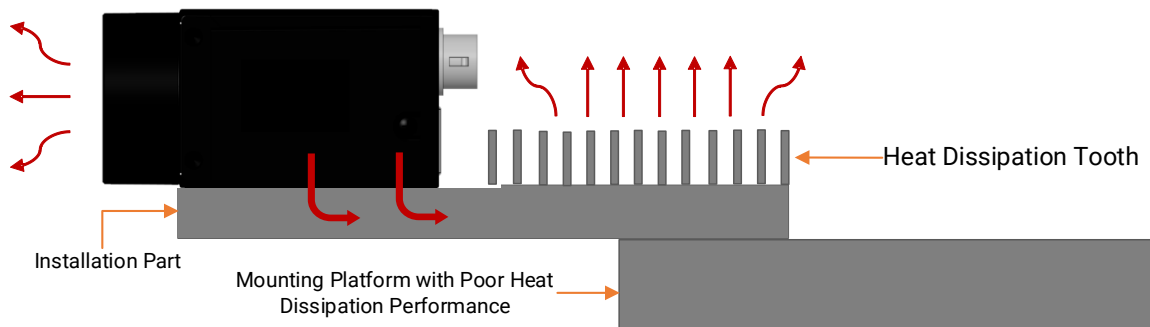
## Heat Dissipation via Cooling Fan

For cases where the installation parts are made of plastic and other materials with poor heat conduction, ventilation equipment such as cooling fans and air conditioners can be used to increase the air flow on the surface of the device and reduce the air temperature around the device, thereby enhancing the convective heat dissipation of the device into the air.

### 5.2.3 Low Heat Conduction Material

If the mounting platform is made of materials with very poor heat conduction such as plastic and wall, heat dissipation can be improved in the following ways:

- Increase the surface area of the installation part.  
If the installation part is in good contact with the device, it can be regarded as a part of the device's housing. The larger the heat dissipation area of the housing, the better the heat dissipation effect. Therefore, the larger the surface area of the installation part, the better the heat dissipation effect.
- The installation part can be made into a metal heat dissipation tooth shape, or a large area flat plate to improve the heat dissipation effect.



**Figure 5-5 Add Heat Dissipation Tooth**

- The surface of the installation part should be in contact with air as much as possible, not with a mounting platform with poor heat conduction.
- While increasing the heat dissipation area of the installation part, painting and oxidation can be used to increase the radiation heat exchange of the installation part to the external environment and strengthen the heat dissipation of the device.

## Chapter 6 Quick Start Guide

The overall workflow of using the device is shown below:

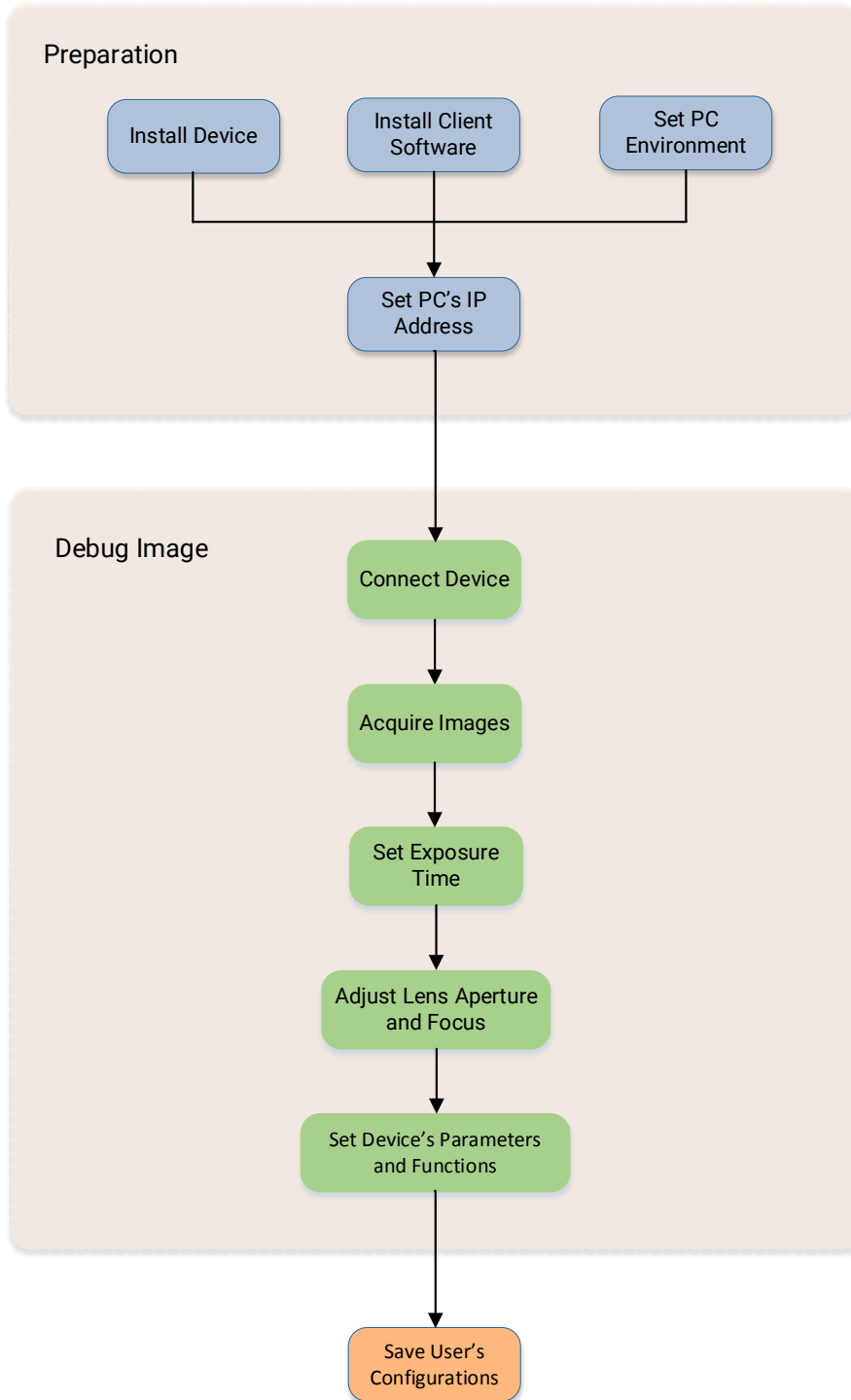


Figure 6-1 Workflow

## 6.1 Install Device

### 6.1.1 Installation Preparation

You need to prepare following accessories before device installation.

**Table 6-1 Accessories**

No.	Name	Quantity	Description
1	Power and I/O Cable	1	It refers to the 6-pin or 12-pin power and I/O cable. You need to purchase separately.
2	DC Power Supply	1	You should select suitable power adapter or switch power supply according to the device power supply and consumption. You need to purchase separately.
3	Network Cable	1	It refers to CAT-5e network cable or above. You need to purchase separately.
4	Lens	1	It refers to the lens that is suitable for the device. You need to purchase separately.
5	Lens Adapter	1	If the lens you used does not match with lens mount of the device, you need to use a lens adapter. You need to purchase separately.

#### Note

- The device mentioned in this manual is an electronic product that requires operation and storage under dry conditions. In case of hot and humid, acidic and alkaline environment, please take isolation and protection measures to avoid corrosion damage of the device's internal components.
- When using the lens, it is necessary to prevent humid environment and avoid steam from entering inside, causing fogging.

### 6.1.2 Install

#### **Before You Start**

- Make sure that the device in package is in good condition and all assembly parts are included.
- Make sure that all related devices are powered off during the installation.

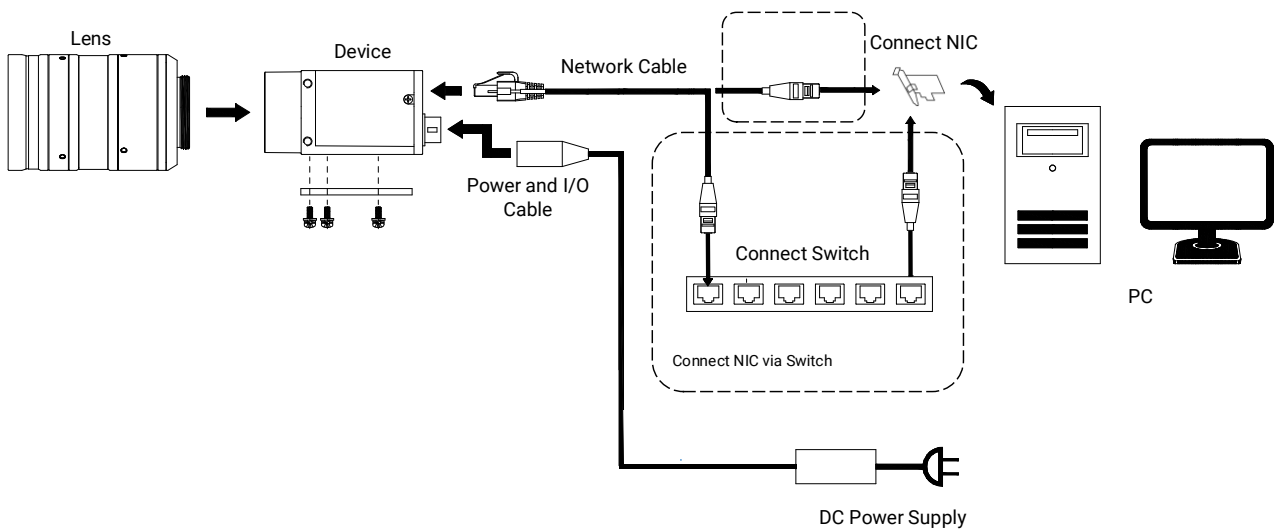
#### **Steps**

1. Fix the device to the installation position.

## Note

When fixing the device to the installation position, measures such as heat dissipation via the installation part or heat dissipation via the cooling fan can be taken to improve the heat dissipation efficiency of the device.

2. Install the lens to the device.
3. Use a proper network cable to connect device with a GigE switch or a network interface card.
4. Select a power supply method:
  - Direct power supply: Use the 6-pin or 12-pin power and I/O cable to connect device to a proper power adapter.
  - PoE (Power over Ethernet): For the device that supports PoE, use a network cable to connect the device to a switch that supports PoE or a network interface card.



**Figure 6-2 Topology Diagram**

## Note

The topology diagram is for reference only.

## 6.2 Install Client Software

MVS client software is used to connect and set device's parameters, and acquire images.

## Note

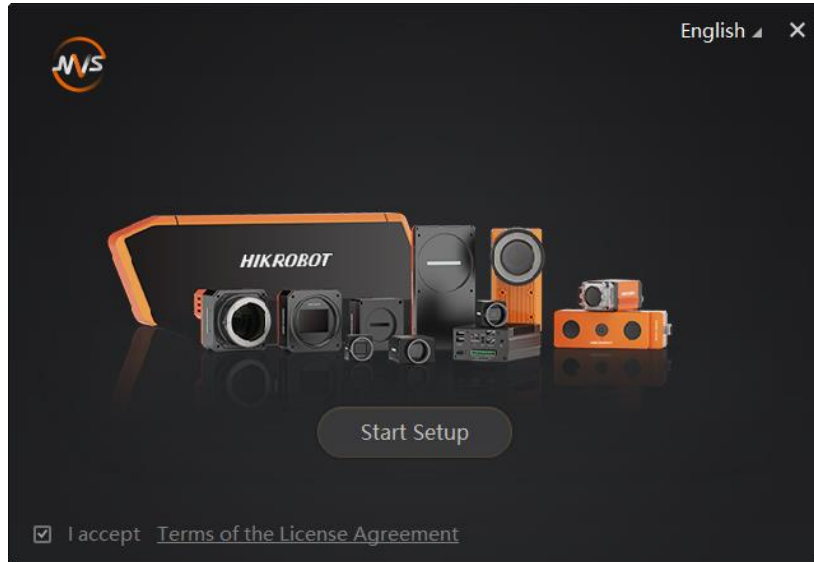
- The MVS client software is compatible with 32/64-bit Windows XP/7/10, 64-bit Windows 11, 32/64-bit Linux, 64-bit MacOS, and Android 4.4 to 9.0 operating systems. Here we take Windows as an example.
- The graphic user interface may differ by different versions of client software you use.
- The client software has integrated driver required by hardware, and no need to download

and install other drivers.

- You can download the client software from [en.hikrobotics.com](http://en.hikrobotics.com).
- 

### Steps

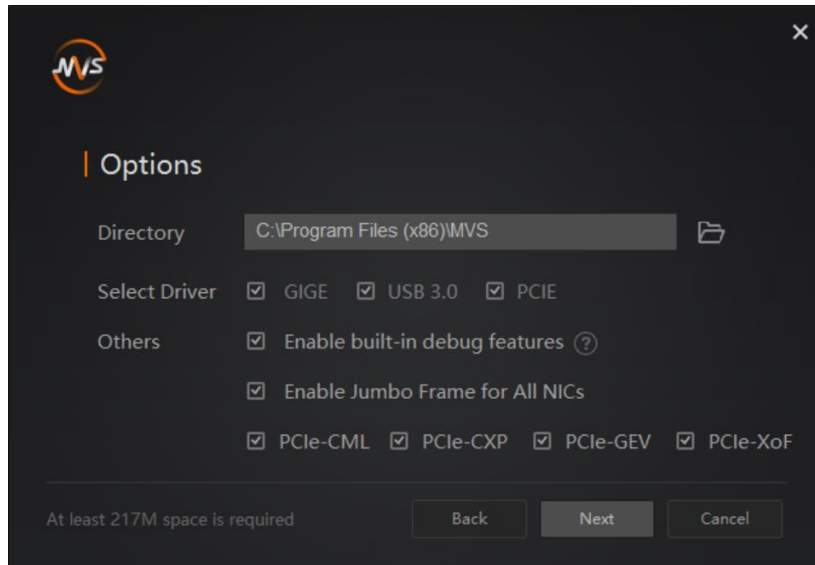
1. Double click the MVS installation package.
2. Select the language.
3. Read and check **Terms of the License Agreement**.



**Figure 6-3 Installation Window**

4. Click **Start Setup**.
5. Select installation directory, driver and others.
  - **Select Driver:** You can check **GIGE**, **USB 3.0** and **PCIE** according to actual demands.
  - **Others:** Check **Enable built-in debug features** to make it easier to use breakpoints while the device is connected and streaming images. Check **Enable Jumbo Frame for All NICs** to enhance network transmission performance. Check **PCIE-CML**, **PCIE-CXP**, **PCIE-GEV**, **PCIE-XoF** to enumerate the corresponding frame grabbers.





**Figure 6-4 Installation Options**

---

### Note

- Regarding options, it is recommended to keep default settings.
- **PCle-CML, PCle-CXP, PCIE-GEV, PCIE-XoF** can be checked only when **PCIE** is checked.
- **PCle-CML, PCle-CXP, PCIE-GEV, PCIE-XoF** supports frame grabbers developed by our company only.

- 
6. Click **Next** to install.
  7. Finish the installation process according to the prompts.

## 6.3 Set PC Environment

To ensure stable client running and data transmission, you are recommended to set PC environment.

### 6.3.1 Turn off Firewall

#### Steps

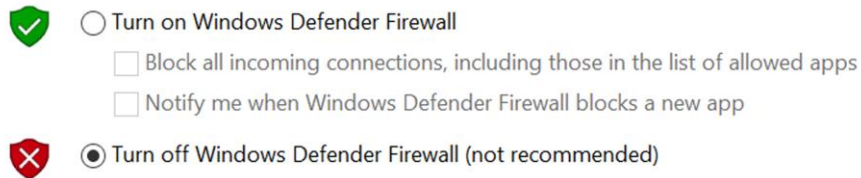
---

### Note

For different Windows versions, the path name or interface may differ. Please refer to the actual condition.

- 
1. Go to Windows Firewall.
    - Windows XP system: Click **Start** → **Control Panel** → **Security Center** → **Windows Firewall**.
    - Windows 7 system: Click **Start** → **Control Panel** → **Windows Firewall**.

- Windows 10 system: Click **Start** → **Control Panel** → **System and Security** → **Windows Defender Firewall**.
- 2. Click **Turn Windows Defender Firewall on or off** on the left.
- 3. Select **Turn off Windows Defender Firewall (not recommended)**.



**Figure 6-5 Windows Defender Firewall**

- 4. Click **OK**.

### 6.3.2 Set PC Network

#### Steps

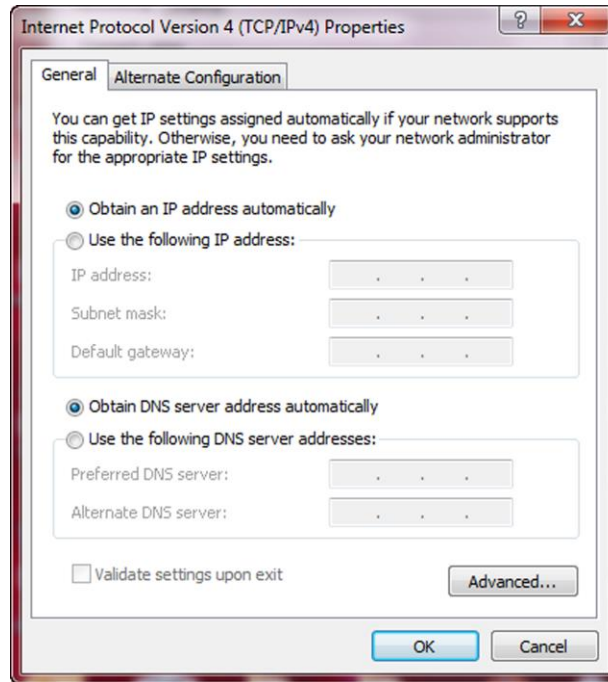
---

##### **Note**

For different Windows versions, the specific setting path and interface may differ. Please refer to the actual condition.

---

1. Go to PC network settings page: **Start** → **Control Panel** → **Network and Internet** → **Network and Sharing Center** → **Change adapter settings**.
2. Select NIC and set the IP obtainment mode.
  - Select **Obtain an IP address automatically** to get an IP address of the PC automatically.
  - Or select **Use the following IP address** to set an IP address for the PC manually.



**Figure 6-6 Set PC Network**

3. Set NIC property via the PC.

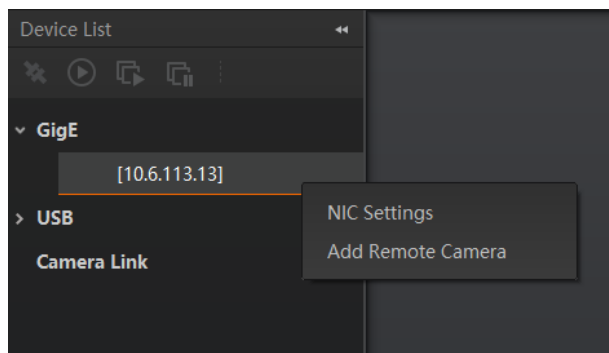
1) Go to NIC settings page: **Control Panel** → **Hardware and Sound** → **Device Manager** → **Network Adapter**.

2) Select corresponding network interface card, and click **Advanced**.

3) Set **Jumbo Packet** value to 9014 Bytes, **Transmit Buffers** and **Receive Buffers** to 2048, **Interrupt Moderation Rate** to **Extremum**.

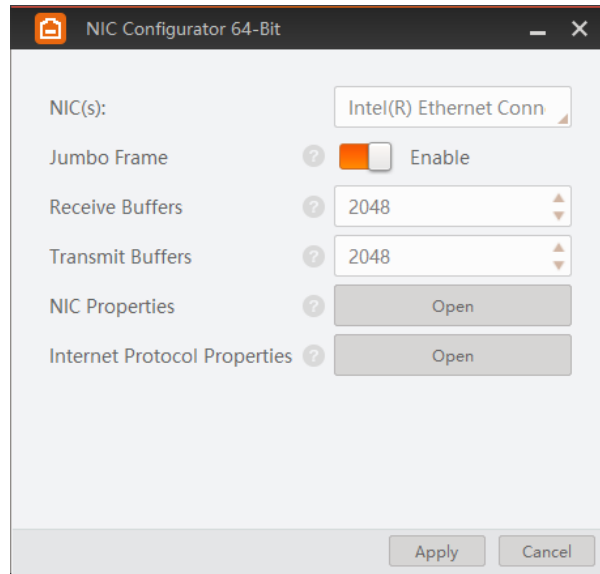
4. (Optional) Set NIC property via the MVS.

1) Right click the **GigE**, and click **NIC Settings**.



**Figure 6-7 Click NIC Settings**

2) Enable **Jumbo Frame**, and set **Receive Buffers** and **Transmit Buffers** to 2048.




**Figure 6-8 NIC Configurator**

## 6.4 Set Device Network

You can set and operate the device in the client software only when the device is in the same network segment with the PC where the client software is installed.

### Steps


1. Double click the client software to run it.
2. Click  in device list to search the device.
3. Select a device to be connected.
4. Right click the device and click **Modify IP**.
5. Set the IP address of the device in the same network segment with the PC.
6. Click **OK**.



**Figure 6-9 Set Device Network**

## 6.5 Basic Operation

### Steps

1. Double click the device name in the device list, or click  to connect the device to the client software.

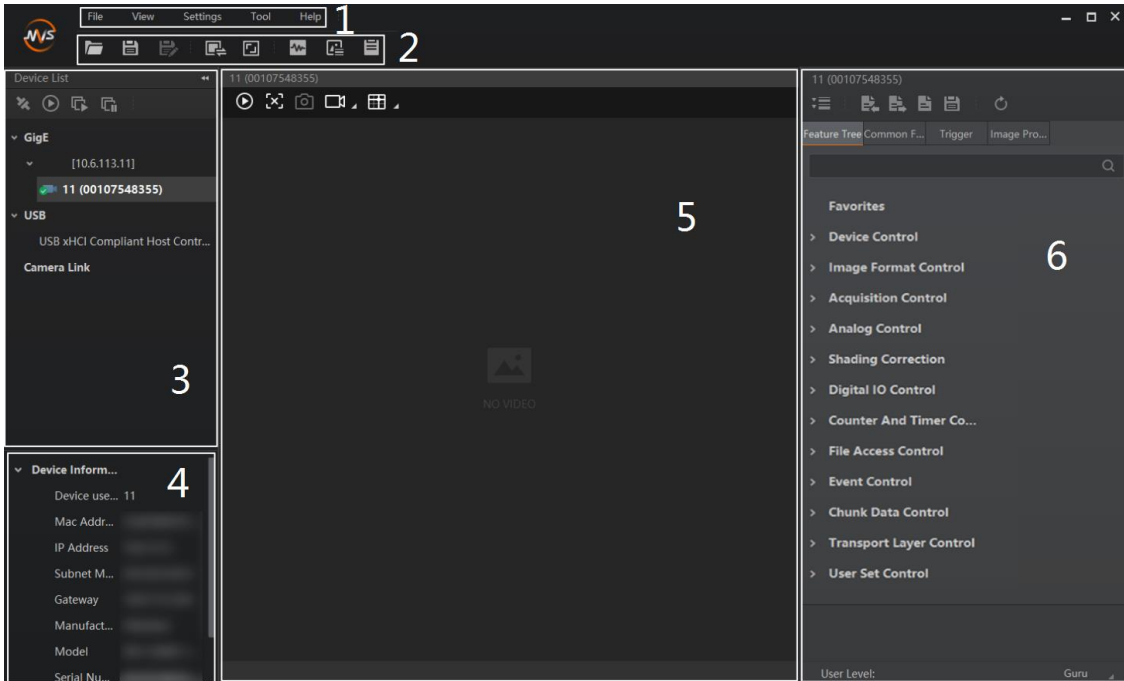


Figure 6-10 Main Window


### Note

For specific main window of the client software, please refer to the actual one you got.

Table 6-2 Main Window Description

No.	Name	Description
1	Menu Bar	The menu bar displays function modules, including File, View, Settings, Tool, and Help.
2	Control Toolbar	The control toolbar provides quick operations for the device.
3	Device List Panel	This panel displays device list, and you can connect or disconnect device, modify device IP address, etc.
4	Device Information Panel	This panel displays the detailed device information.
5	Display Window	This area displays the acquisition images in real-time. You can click different icons to capture and save image, record, etc.

No.	Name	Description
6	Feature Panel	You can view and set features of the selected device, and perform operations such as importing, exporting, and saving features.

2. Set the device's pixel format, exposure time, etc., in the feature panel.
3. Click  in the display window to acquire images continuously.
4. Adjust the device's aperture and focus to have clear images.
5. (Optional) Set the device's other parameters in the feature panel.

---

 **Note**

The device's feature tree and parameters may differ by device models.

---

## Chapter 7 I/O Electrical Features and Wiring

### 7.1 I/O Electrical Features

#### 7.1.1 Electrical Features of Input Signal

The internal circuit of opto-isolated input (Line 0) is as follows.

##### Note

- The maximum input current of Line 0 is 25 mA.
- Make sure that the input voltage is not from 1 VDC to 3.3 VDC as the electric status between these two values are not stable.
- The breakdown voltage is 30 VDC. Keep voltage stable.

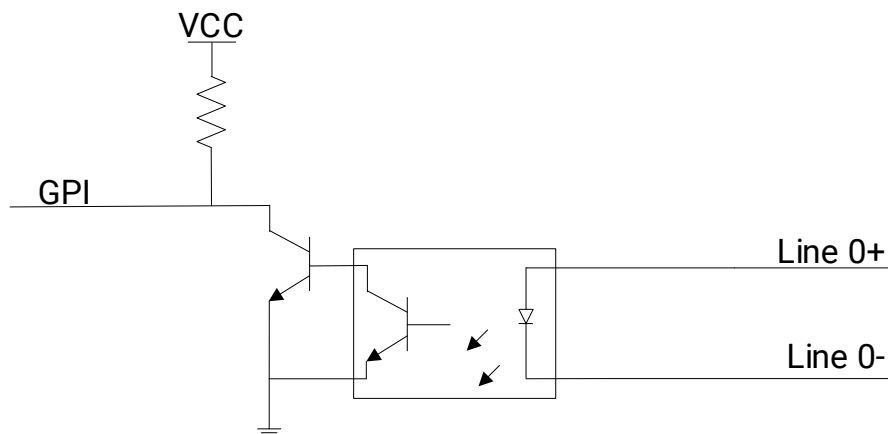


Figure 7-1 Internal Circuit of Input Signal

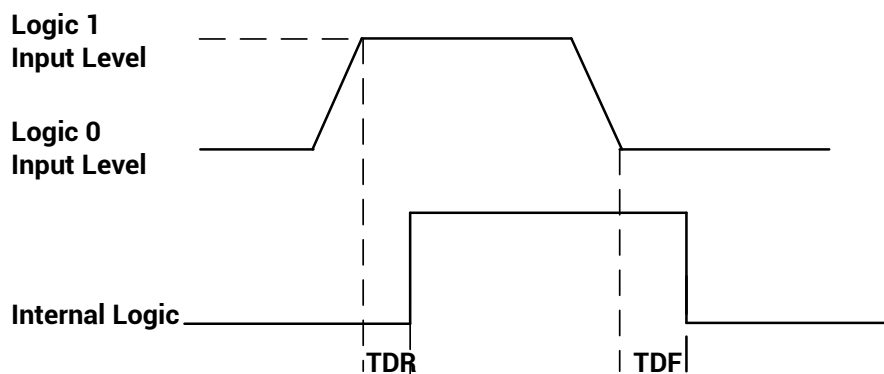


Figure 7-2 Input Logic Level

**Table 7-1 Input Electrical Feature**

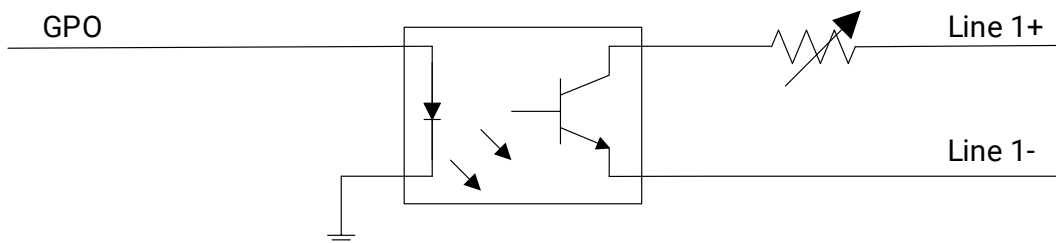
Parameter Name	Parameter Symbol	Value
Input Logic Level Low	VL	0 VDC to 1 VDC
Input Logic Level High	VH	3.3 VDC to 24 VDC
Input Falling Delay	TDF	16.8 $\mu$ s to 22 $\mu$ s
Input Rising Delay	TDR	1.8 $\mu$ s to 4.6 $\mu$ s

### 7.1.2 Electrical Features of Output Signal

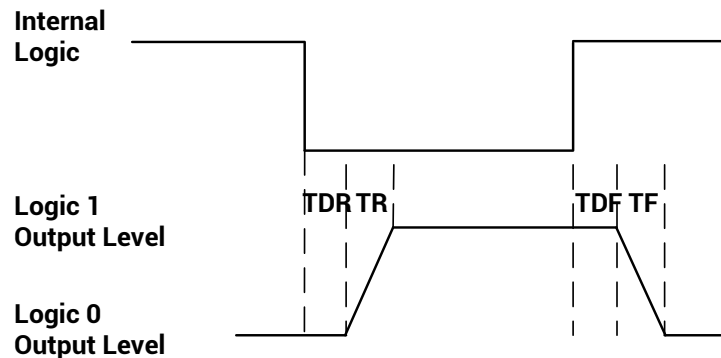
The internal circuit of opto-isolated output (Line 1) is as follows.

**Note**

The maximum output current of Line 1 is 25 mA.



**Figure 7-3 Internal Circuit of Output Signal**



**Figure 7-4 Output Logic Level**



The electrical features of opto-isolated output when the external voltage is 3.3 VDC and the external resistance is 1 K $\Omega$  is shown below.

**Table 7-2 Output Electrical Feature**

Parameter Name	Parameter Symbol	Value
Output Logic Level Low	VL	575 mV
Output Logic Level High	VH	3.3 VDC
Output Rising Time	TR	8.4 $\mu$ s
Output Falling Time	TF	1.9 $\mu$ s
Output Rising Delay	TDR	15 $\mu$ s to 60 $\mu$ s
Output Falling Delay	TDF	3 $\mu$ s to 6 $\mu$ s

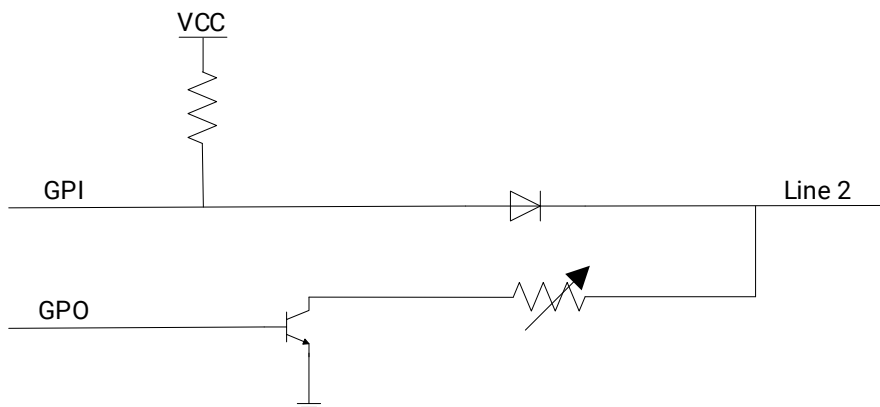
With different external voltage and resistance, the corresponding current and the parameter of output logic level low are shown below.

**Table 7-3 Parameters of Output Logic Level Low**

External Voltage	External Resistance	VL	Output Current
3.3 VDC	1 K $\Omega$	575 mV	2.7 mA
5 VDC	1 K $\Omega$	840 mV	4.1 mA
12 VDC	2.4 K $\Omega$	915 mV	4.6 mA
24 VDC	4.7 K $\Omega$	975 mV	4.9 mA

### 7.1.3 Electrical Features of Bi-Directional Signal

The device has one bi-directional non-isolated I/O signal (Line 2), and you can set it as input signal or output signal according to demands. Its internal circuit is as follows.



**Figure 7-5 Internal Circuit of Bi-Directional Signal**

## Configured as Input Signal

### Note

- Make sure that the input voltage is not from 0.3 VDC to 3.3 VDC as the electric status between these two values are not stable.
- The breakdown voltage is 30 VDC. Keep voltage stable.
- To prevent damage to the GPIO pin, please connect GND first and then input voltage in Line 2.

With the condition of 100  $\Omega$  resistance and 5 VDC voltage, the logic level and electrical feature of configuring Line 2 as input signal are shown below.

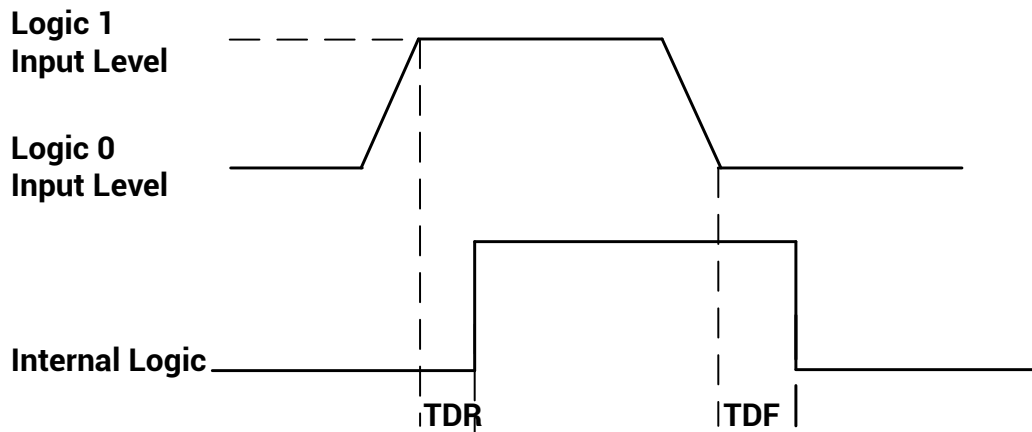


Figure 7-6 Input Logic Level

Table 7-4 Input Electrical Feature

Parameter Name	Parameter Symbol	Value
Input Logic Level Low	VL	0 VDC to 0.3 VDC
Input Logic Level High	VH	3.3 VDC to 24 VDC
Input Falling Delay	TDF	< 1 $\mu$ s
Input Rising Delay	TDR	< 1 $\mu$ s

## Configured as Output Signal

### Note

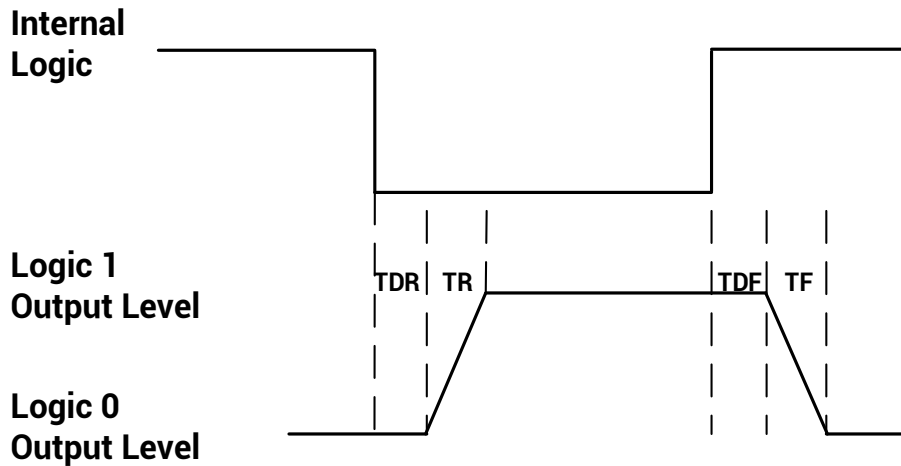
The maximum current is 25 mA and the output impedance is 40  $\Omega$ .

The relation among external voltage, resistance and the output level low is shown below.

**Table 7-5 Parameters of Output Logic Level Low**

External Voltage	External Resistance	VL (GPIO2)
3.3 VDC	1 K $\Omega$	160 mV
5 VDC	1 K $\Omega$	220 mV
12 VDC	1 K $\Omega$	460 mV
24 VDC	1 K $\Omega$	860 mV
30 VDC	1 K $\Omega$	970 mV

When the voltage of external resistance (1 K $\Omega$ ) is pulled up to 5 VDC, the logic level and electrical feature of configuring Line 2 as output are shown below.



**Figure 7-7 Output Logic Level**

**Table 7-6 Output Electrical Feature**

Parameter Name	Parameter Symbol	Value
Output Logic Level Low	VL	220 mV
Output Logic Level High	VH	4.75 VDC
Output Rising Time	TR	0.06 $\mu$ s
Output Falling Time	TF	0.016 $\mu$ s
Output Rising Delay	TDR	0 $\mu$ s to 4 $\mu$ s
Output Falling Delay	TDF	< 1 $\mu$ s

## 7.1.4 Factors Affecting Transmission Delay of I/O Lines

The factors that affect the transmission delay of I/O lines are shown below, where ★ represents the main influencing factor and ☆ represents the secondary factor.

**Table 7-7 Factors Affecting Transmission Delay of I/O Lines**

Lines Factors	Opto-Isolated Input Lines	GPIO Input Lines	Opto-Isolated Output Lines	GPIO Output Lines
Working Temperature	★	☆	★	☆
Production Differences of Electronic Components	★	☆	★	☆
Aging	★	-	★	-
External I/O Power Supply Voltage	★	-	★	☆
Load Resistance	-	-	★	☆
Load Current	-	-	★	☆

Regarding the factors that affect the transmission delay of I/O lines in the table above, we provide the following explanations and suggestions:

- Use the I/O circuit at the recommended working temperature of the device. See the device's datasheet for the working temperature.
- Applying current to the input and output circuits of the opto-coupler will accelerate the aging rate of the opto-coupler. Keep the current to a minimum level, and ensure a stable transmission delay.
- In order to reduce the low-speed transmission delay, it is recommended to use an external I/O supply voltage of about 5 V.
- For a better quick trigger, use the recommended pull-up resistor.
- Generally, the trigger input-output frequency of an opto-coupler circuit rarely exceeds 10 kHz, and the trigger input-output frequency of a GPIO circuit rarely exceeds 1 MHz. Keep the trigger input-output frequency of the circuit within this range.
- If you need to reduce the transmission delay, it is recommended to use the GPIO line, which has a shorter transmission delay than the opto-coupler delay, but the GPIO line has the risk of burning out, please use it with caution.
- The bounce of the trigger signal may cause the internal bounce of the device to increase. To avoid bounce, keep the edge of the trigger signal steep to reduce the internal bounce of the device (preferably less than 1  $\mu$ s).

## 7.2 I/O Wiring

This section introduces how to wire the device via its I/O connector.

### Note

Here we take one kind of device as an example to introduce I/O wiring. The appearance here is for reference only, and the actual device you purchased shall prevail.

### 7.2.1 Input Signal Wiring

The input signal wiring is shown below when the device uses Line 0 as trigger source in external trigger mode.

### Note

Input signal wiring may differ by the external device type.

#### PNP Device

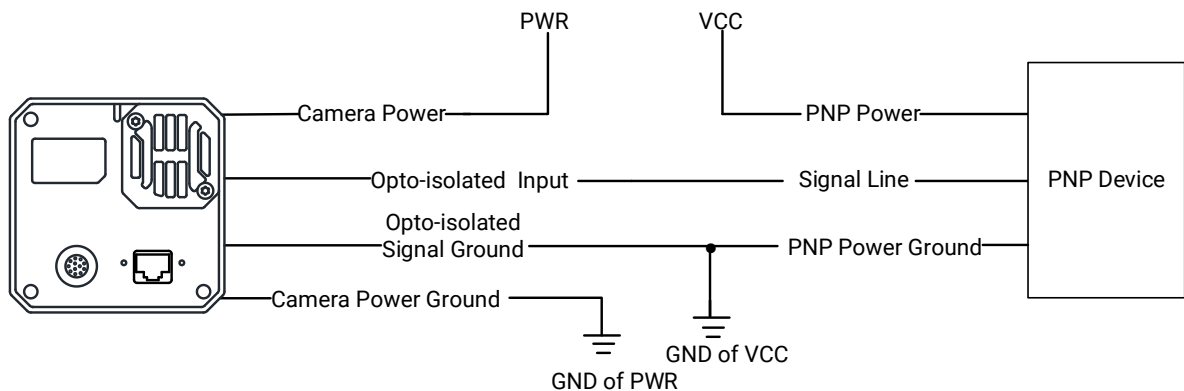
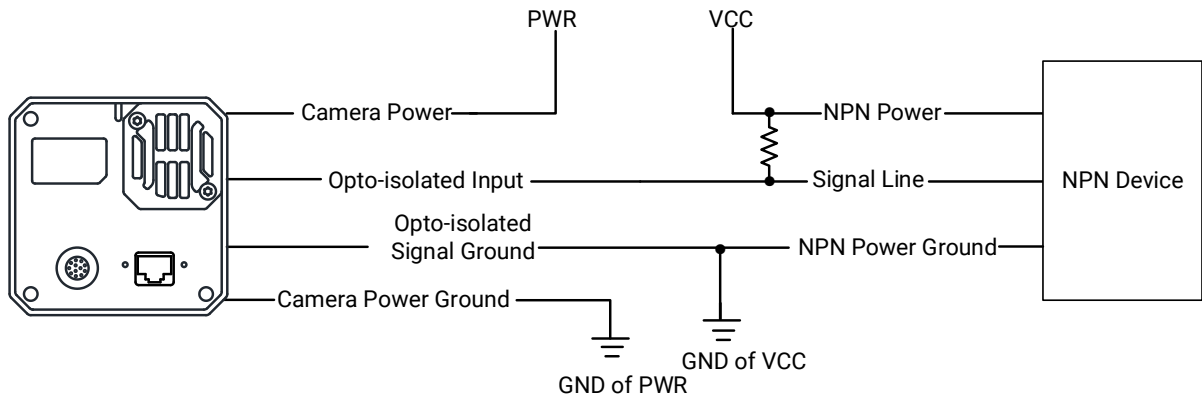


Figure 7-8 Input Signal Connects to PNP Device

#### NPN Device

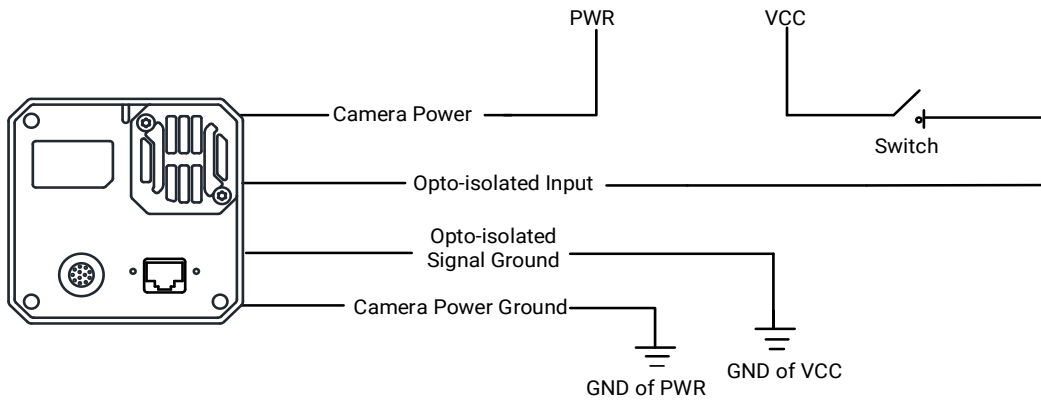
- If the VCC of NPN device is 24 VDC, it is recommended to use 4.7 K $\Omega$  pull-up resistor.
- If the VCC of NPN device is 12 VDC, it is recommended to use 1 K $\Omega$  pull-up resistor.



**Figure 7-9 Input Signal Connects to NPN Device**

## Switch

If the VCC of switch is 24 VDC, it is recommended to use 4.7 K $\Omega$  resistor to protect circuit.



**Figure 7-10 Input Signal Connects to Switch**

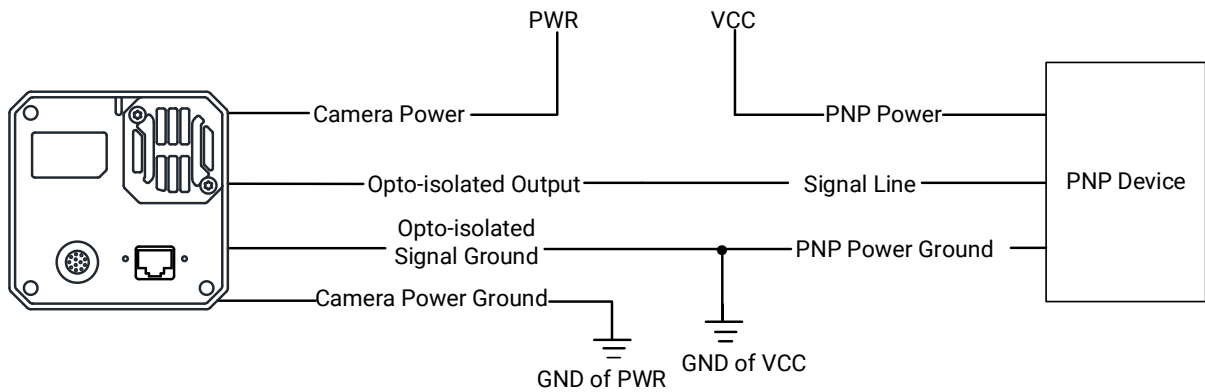
## 7.2.2 Output Signal Wiring

The output signal wiring is shown below when the device uses Line 1 as output signal.

### Note

Output signal wiring may differ by the external device type.

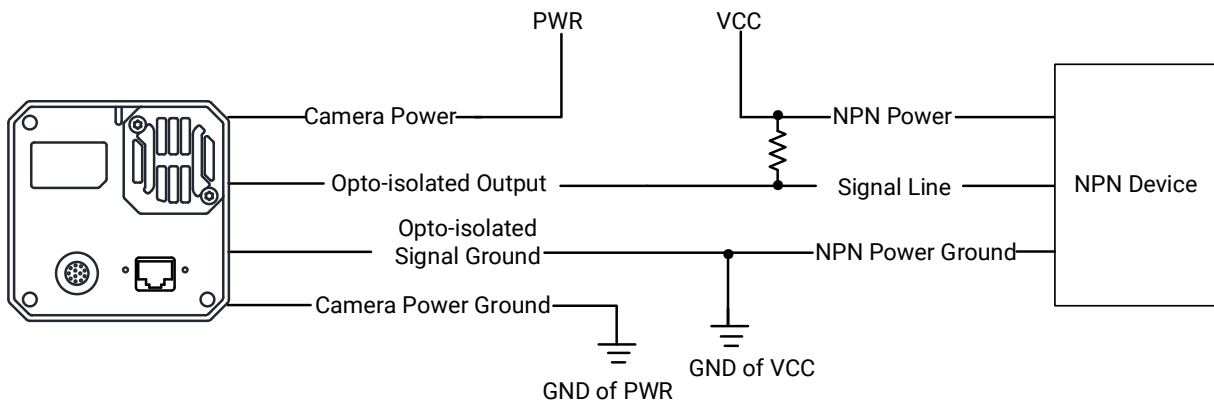
**PNP Device**



**Figure 7-11 Output Signal Connects to PNP Device**

**NPN Device**

- If the VCC of NPN device is 24 VDC, it is recommended to use 4.7 KΩ pull-up resistor.
- If the VCC of NPN device is 12 VDC, it is recommended to use 1 KΩ pull-up resistor.



**Figure 7-12 Output Signal Connects to NPN Device**

**7.2.3 Bi-Directional Signal Wiring**

The device's Line 2 can be used as input signal and output signal.

**Configured as Input Signal**

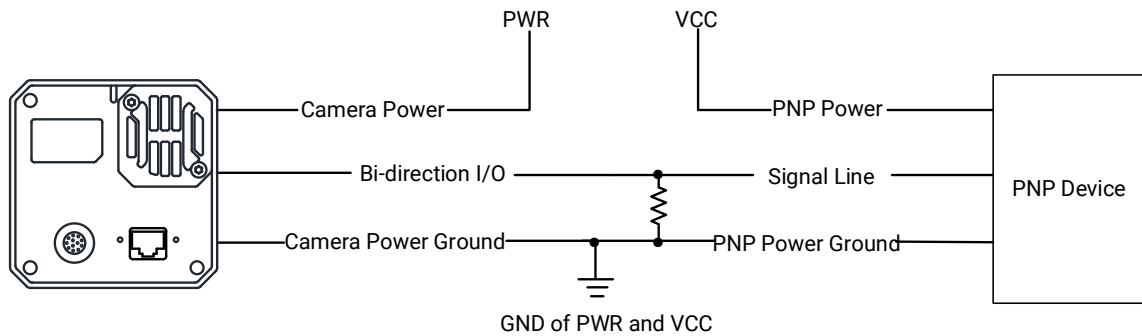
The input signal wiring is shown below when the device's Line 2 is configured as input signal.

**Note**

Input signal wiring may differ by the external device type.

## PNP Device

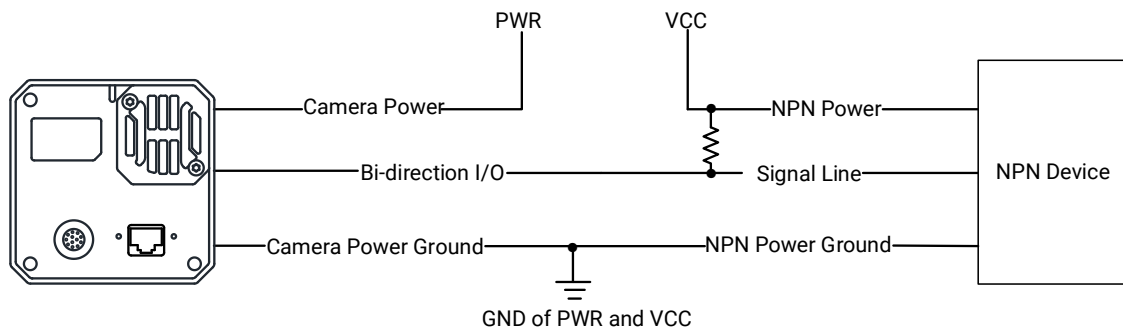
It is recommended to use 330  $\Omega$  pull-down resistor.



**Figure 7-13 Input Signal Connects to PNP Device**

## NPN Device

- If the VCC of NPN device is 24 VDC, it is recommended to use 4.7 K $\Omega$  pull-up resistor.
- If the VCC of NPN device is 12 VDC, it is recommended to use 1 K $\Omega$  pull-up resistor.

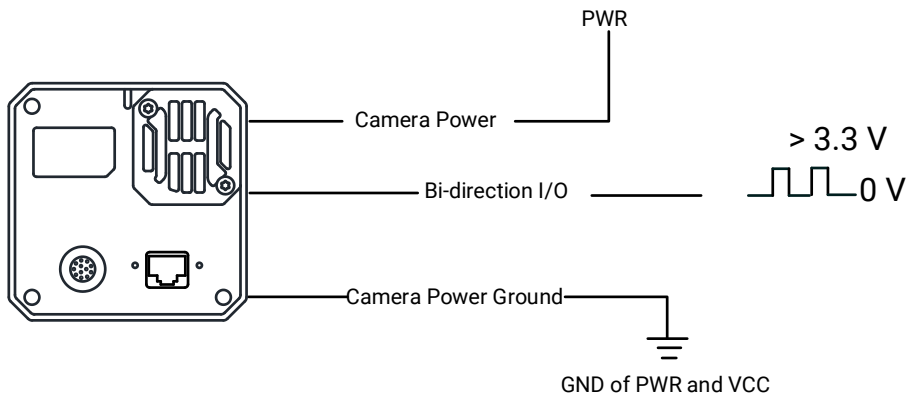


**Figure 7-14 Input Signal Connects to NPN Device**



## Switch

The switch value can provide low electrical level to trigger line 2.



**Figure 7-15 Input Signal Connects to Switch**

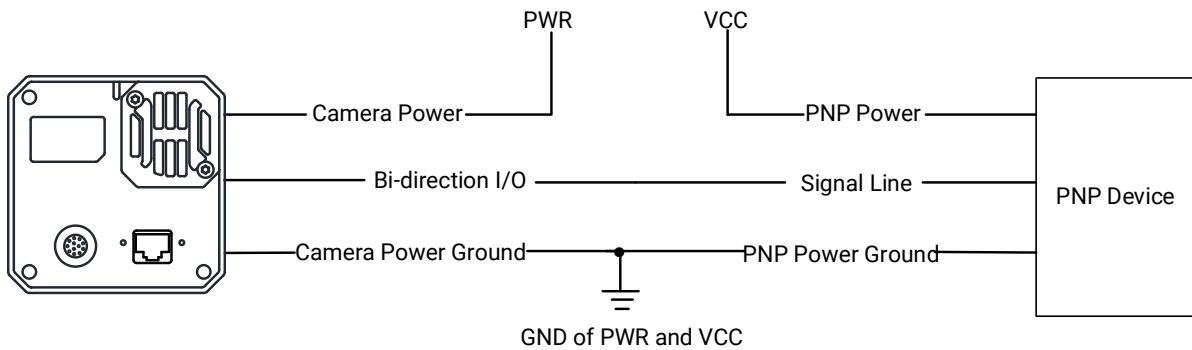
## Configured as Output Signal

The output signal wiring is shown below when the device's Line 2 is configured as output signal.

### Note

Output signal wiring may differ by the external device type.

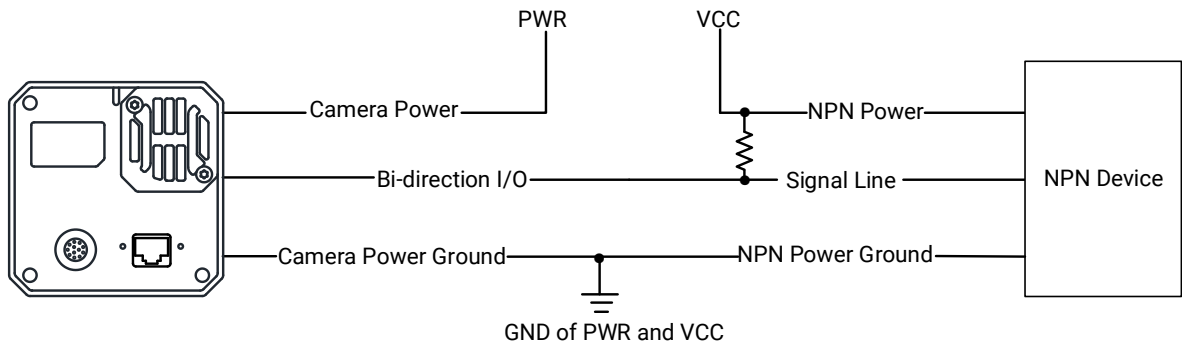
## PNP Device



**Figure 7-16 Output Signal Connects to PNP Device**

## NPN Device

- If the VCC of NPN device is 24 VDC, it is recommended to use 4.7 KΩ pull-up resistor.
- If the VCC of NPN device is 12 VDC, it is recommended to use 1 KΩ pull-up resistor.



**Figure 7-17 Output Signal Connects to NPN Device**

# Chapter 8 Trigger Input and Output

## 8.1 Trigger Input

### 8.1.1 Set Trigger Mode

The device supports two types of trigger modes, including internal trigger mode and external trigger mode. Go to **Scan Control** → **Trigger Control** → **Trigger Mode** and set it.

- **Internal Trigger Mode:** In this mode, the device acquires images via its internal signals.
- **External Trigger Mode:** In this mode, the device acquires images via external signals like software signal and hardware signal. The trigger source of external trigger mode includes software trigger, hardware trigger, counter trigger, action command trigger, and free trigger.

#### Enable Internal Trigger Mode

Go to **Acquisition Control** → **Trigger Mode**, and select **Off** as **Trigger Mode**.

---

#### Note

**Off** refers to the internal trigger mode.

---

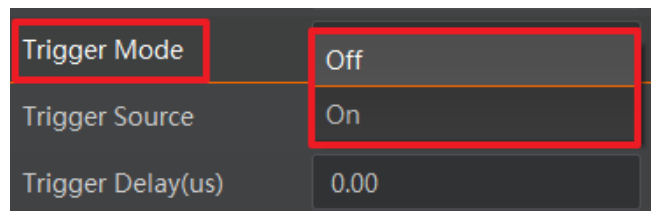


Figure 8-1 Enable Internal Trigger Mode

#### Enable External Trigger Mode

Go to **Acquisition Control** → **Trigger Mode**, and select **On** as **Trigger Mode**.

---

#### Note

**On** refers to the external trigger mode.

---

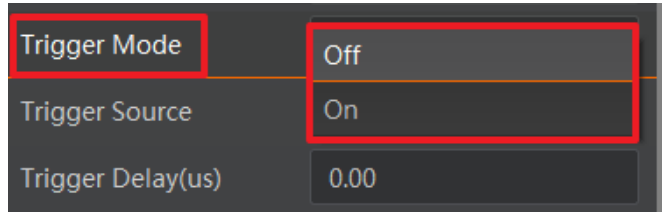


Figure 8-2 Enable External Trigger Mode

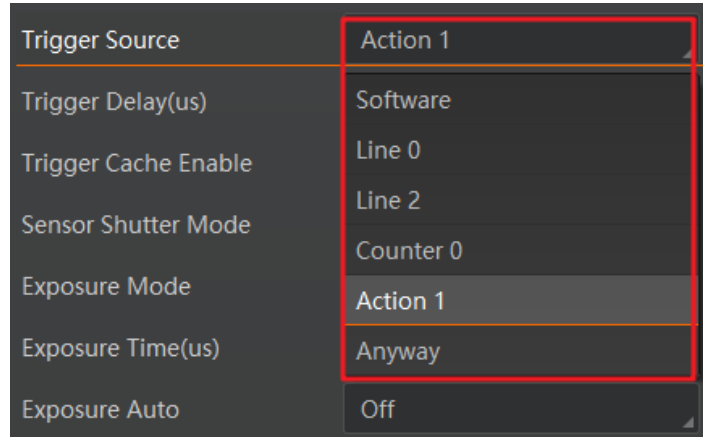
## 8.1.2 Set Trigger Source

### External Trigger Source

The device’s external trigger source includes software trigger, hardware trigger, counter trigger, action command trigger, and free trigger. Go to **Acquisition Control** → **Trigger Source**, and select **Trigger Source** according to actual demands.

Table 8-1 Trigger Source Description

External Trigger Source	Parameter	Description
Software Trigger	Software	The software sends trigger signal to the device via GigE interface to acquire images.
Hardware Trigger	Line 0, Line 2	External device connects device via device I/O interface. External device sends trigger signal to device to acquire images.
Counter Trigger	Counter 0	The counter sends trigger signal to the device to acquire images.
Action Command Trigger	Action 1	The action command sends trigger signal to the device to acquire images. Refer to section <b>Set Action Command</b> for details.
Free Trigger	Anyway	The device can receive software trigger and hardware trigger to acquire images.



**Figure 8-3 External Trigger Source**

---

**Note**

These five external trigger sources are valid only when the **Trigger Mode** is **On**.

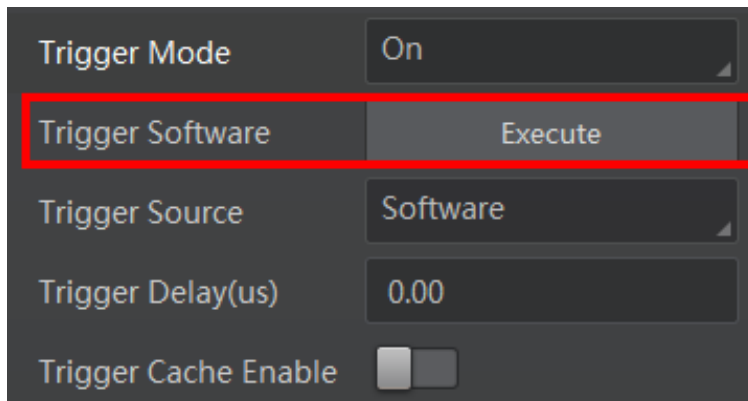
---

## Set and Execute Software Trigger

In software trigger, the software sends trigger signal to the device via GigE interface to acquire images.

### Steps

1. Go to **Acquisition Control** → **Trigger Mode**, and select **On** as **Trigger Mode**.
2. Select **Software** as **Trigger Source**.
3. Click **Execute** in **Trigger Software**.



**Figure 8-4 Set and Execute Software Trigger**

## Set and Execute Hardware Trigger

In hardware trigger, external device sends trigger signal to the device to acquire images via I/O connector.

### Steps

1. Go to **Acquisition Control** → **Trigger Mode**, and select **On** as **Trigger Mode**.
2. Select **Line 0** or **Line 2** as **Trigger Source** according to actual demands.

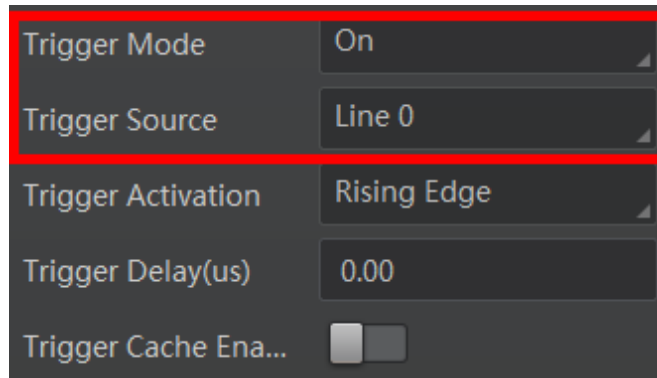


Figure 8-5 Set Line 0 or Line 2 as Input Signal

The device has one opto-isolated input (Line 0), and one bi-directional I/O (Line 2) that can be configured as input signal. Make sure that Line 2 is input signal if you want to use it as trigger source.

### Steps

1. Go to **Digital IO Control** and select **Line 2** as **Line Selector**.
2. Select **Input** as **Line Mode**.

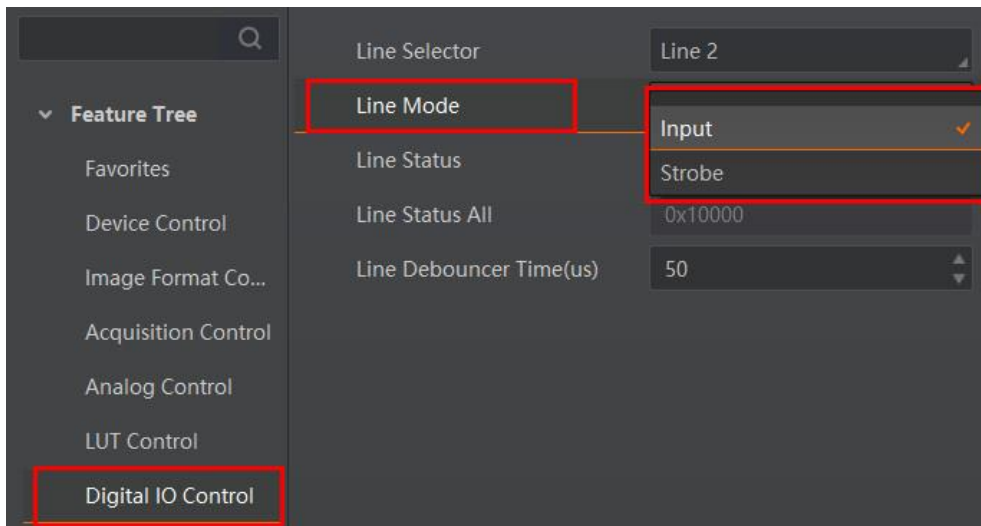


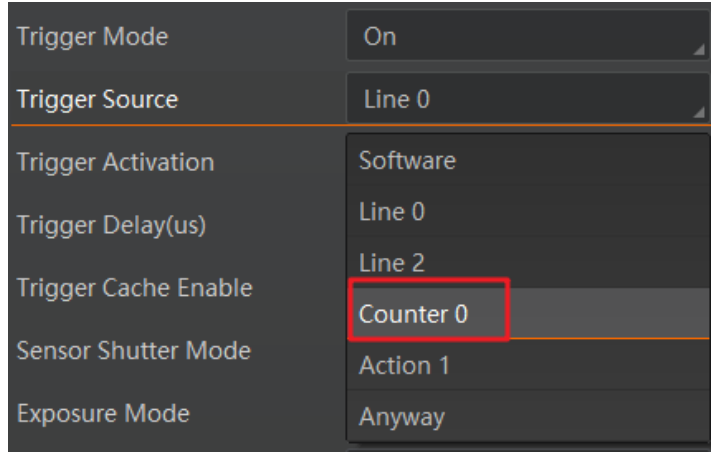
Figure 8-6 Set Line 2 as Input Signal

## Set and Execute Counter Trigger

In counter trigger, the counter sends trigger signal to the device to acquire images.

### Steps

1. Go to **Acquisition Control** → **Trigger Mode**, and select **On** as **Trigger Mode**.
2. Select **Counter 0** as **Trigger Source**.

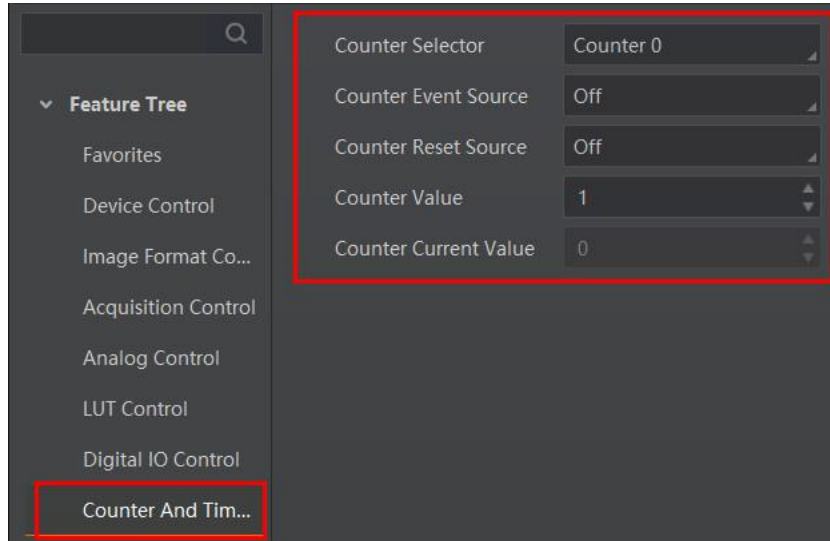


**Figure 8-7 Set and Execute Counter Trigger**

When using counter trigger, you need to set parameters of **Counter and Timer Control** as shown below.

**Table 8-2 Parameters of Counter and Timer Control**

Parameter	Read/Write	Description
Counter Selector	Read & Write	It selects counter source. <b>Counter 0</b> is available only at present.
Counter Event Source	Read & Write	It selects the signal source of counter trigger. <b>Line 0</b> or <b>Line 2</b> is available. This parameter is disabled by default.
Counter Reset Source	Read & Write	It selects the signal source of resetting counter. <b>Software</b> is available only. This parameter is disabled by default.
Counter Reset	Write is available under certain condition	It resets counter and it can be executed only when selecting <b>Software</b> as <b>Counter Reset Source</b> .
Counter Value	Read & Write	It is the counter value with the range of 1 to 1023.
Counter Current Value	Read Only	It displays the number of executed external trigger.



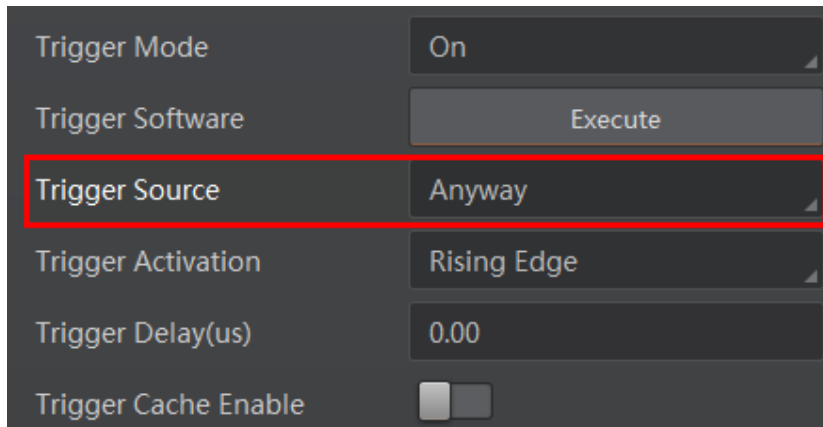
**Figure 8-8 Counter and Timer Control**

## Set and Execute Free Trigger

In free trigger, the device can receive software trigger and hardware trigger to acquire images.

### Steps

1. Go to **Acquisition Control** → **Trigger Mode**, and select **On** as **Trigger Mode**.
2. Select **Anyway** as **Trigger Source**.



**Figure 8-9 Set and Execute Free Trigger**



### 8.1.3 Set Trigger Related Parameters

In external trigger mode, you can set five related parameters, including acquisition burst frame count, trigger delay, trigger cache, trigger activation, and trigger debouncer.

**Note**

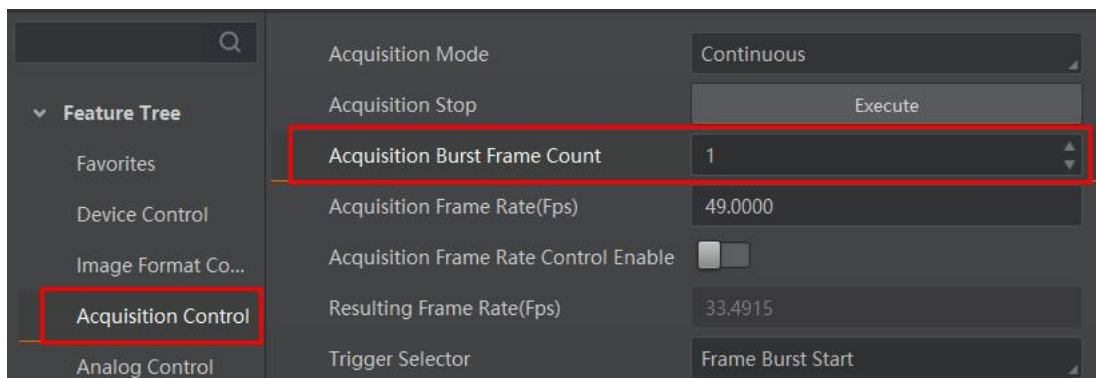
- Different trigger sources can set various parameters in external trigger mode.
- √ is supported, and × is not supported.

**Table 8-3 Trigger Source and Trigger Related Parameters**

Trigger Source Trigger Parameters	Software Trigger	Hardware Trigger	Counter Trigger	Action Command Trigger	Free Trigger
Acquisition Burst Frame Count	√	√	√	√	√
Trigger Delay	√	√	√	√	√
Trigger Cache	√	√	√	√	√
Trigger Activation	×	√	√	×	×
Trigger Debouncer	×	√	√	×	Partially Supported

#### Set Acquisition Burst Frame Count

In external trigger mode, you can set acquisition burst frame count. Go to **Acquisition Control** → **Acquisition Burst Frame Count**, and enter **Acquisition Burst Frame Count** according to actual demands.



**Figure 8-10 Set Acquisition Burst Frame Count**

## Note

- The range of **Acquisition Burst Frame Count** is from 1 to 1023.
- If **Acquisition Burst Frame Count** is 1, the device is in single frame trigger mode. If **Acquisition Burst Frame Count** is larger than 1, the device is in multi-frame trigger mode.
- If **Acquisition Burst Frame Count** is n, when input 1 trigger signal to the device, the device stops acquiring images after exposing n times and outputting n frame images.
- The sequence diagram below uses rising edge as trigger activation.



Figure 8-11 Sequence Diagram of Acquisition Burst Frame Count

## Set Trigger Delay

The trigger delay function allows the device to add a delay between the receipt of trigger signal and the moment the trigger becomes active. Go to **Acquisition Control** → **Trigger Delay**, and enter **Trigger Delay**, and the unit is  $\mu\text{s}$ .

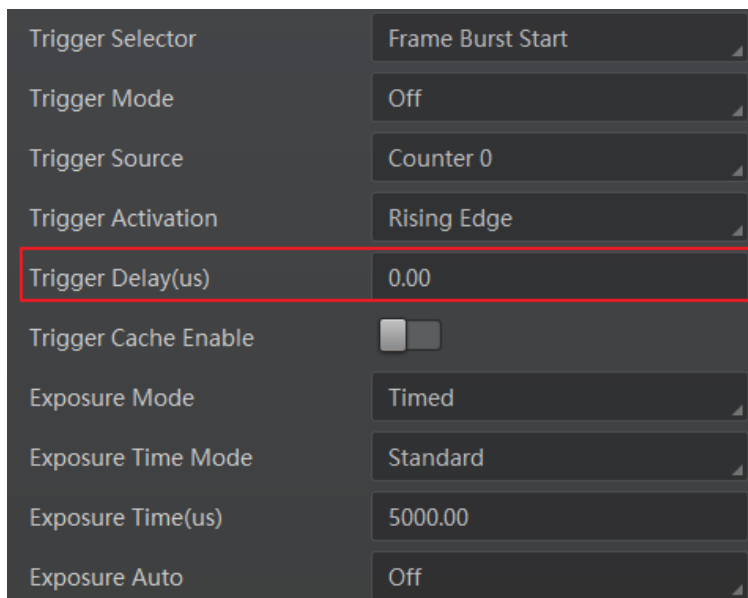
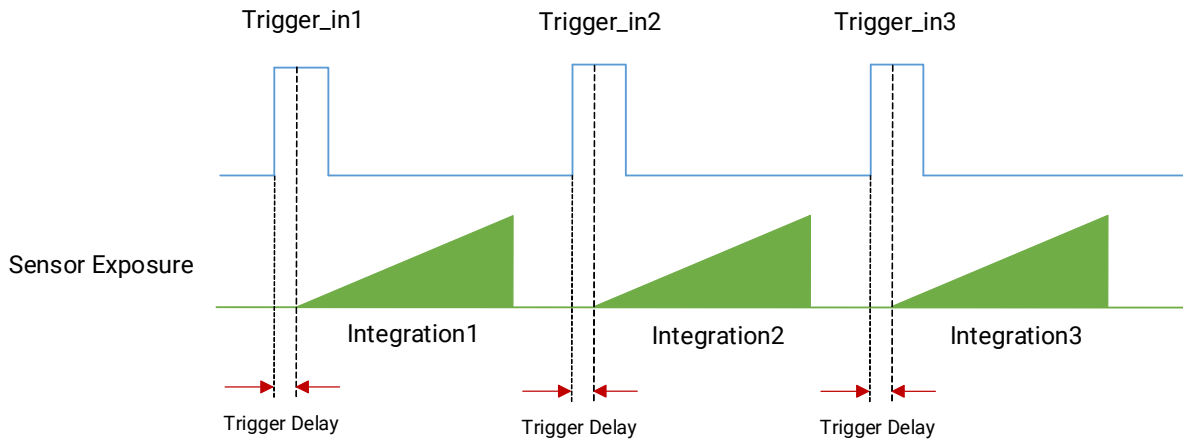


Figure 8-12 Set Trigger Delay



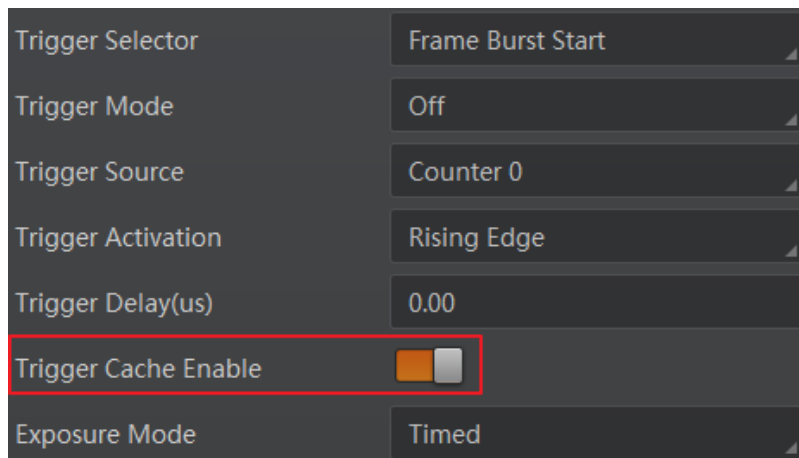
**Figure 8-13 Sequence Diagram of Trigger Delay**

## Note

The sequence diagram above uses rising edge as trigger activation.

## Set Trigger Cache

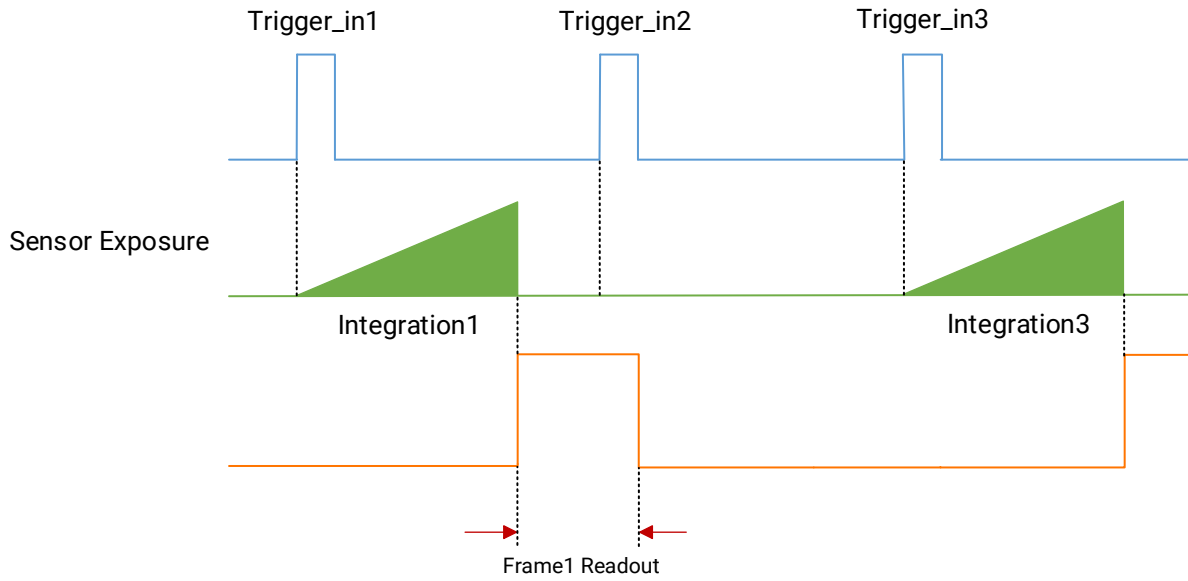
The trigger cache function allows the device to save and process new signal during trigger stage, and the device can save and process three trigger signals at most. Go to **Acquisition Control** → **Trigger Cache Enable**, and enable **Trigger Cache Enable**.



**Figure 8-14 Set Trigger Cache**

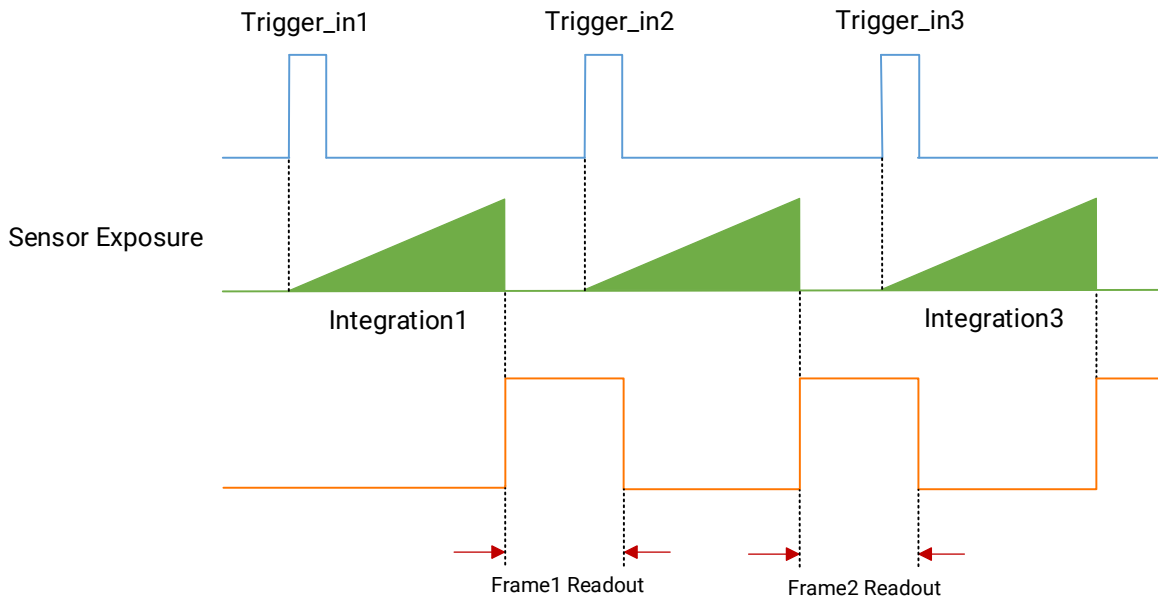
For example, if the device receives the 2nd trigger signal when it is processing the 1st trigger signal, and the result will be different depending on whether **Trigger Cache Enable** is enabled or not.

- The 2nd trigger signal will be filtered without processing if **Trigger Cache Enable** is disabled.



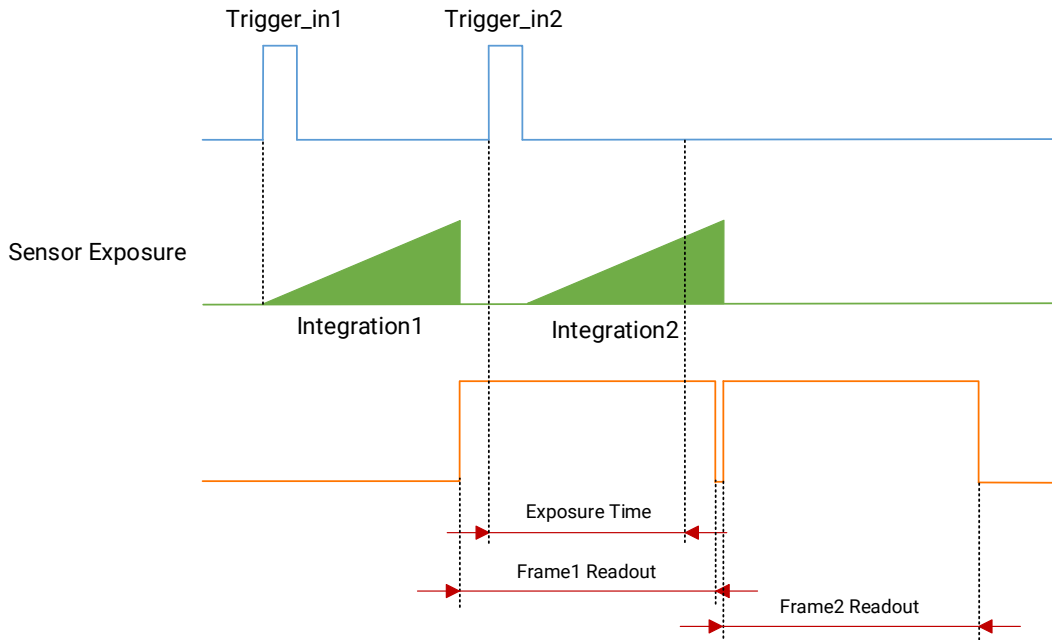
**Figure 8-15 Second Frame Filtered**

- The 2nd trigger signal will be saved if **Trigger Cache Enable** is enabled. If the 1st frame image's exposure time of the 2nd trigger signal is not earlier than the device's last frame creation time of the 1st trigger signal, and then the 2nd trigger signal's 1st frame image is created normally.



**Figure 8-16 Second Frame Created Normally**

If the 1st frame image's exposure time of the 2nd trigger signal is earlier than the device's last frame creation time of the 1st trigger signal, and then the device will delay this exposure time. Thus making sure this exposure time is not earlier than the device's last frame creation time of the 1st trigger signal.



**Figure 8-17 Sequence Diagram**

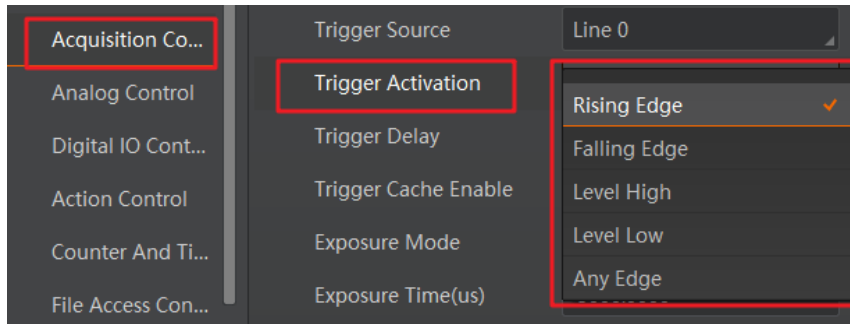
## Note

The three sequence diagrams above use rising edge as trigger activation.

## Set Trigger Activation

The device supports triggering image acquisition in the rising edge, falling edge, level high, level low or any edge of the external signal. Go to **Acquisition Control** → **Trigger Activation**, and select **Rising Edge**, **Falling Edge**, **Any Edge**, **Level High** or **Level Low** as **Trigger Activation**.

- **Rising Edge:** It means that when the level signal sent by external device is in rising edge, the device receives trigger signal and starts to acquire images.
- **Falling Edge:** It means that when the level signal sent by external device is in falling edge, the device receives trigger signal and starts to acquire images.
- **Any Edge:** It means that when the level signal sent by external device is in rising or falling edge, the device receives trigger signal and starts to acquire images.
- **Level High:** The level high of the trigger signal is valid. As long as the trigger signal is in level high, the device is in image acquisition status.
- **Level Low:** The level low of the trigger signal is valid. As long as the trigger signal is in level low, the device is in image acquisition status.



**Figure 8-18 Set Trigger Activation**

## Set Trigger Debouncer

The trigger debouncer function allows the device to filter out unwanted short external trigger signal that is input to the device.

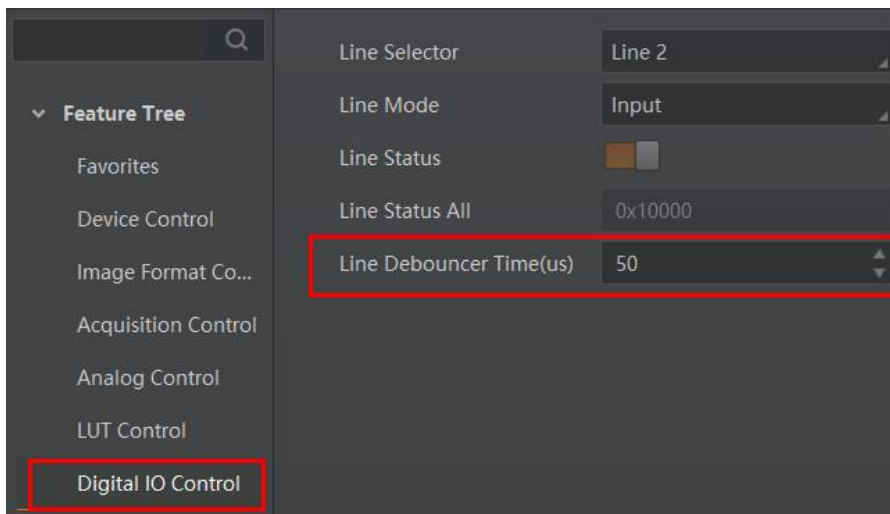
Go to **Digital IO Control** → **Line Debouncer Time**, and enter **Line Debouncer Time** according to actual demands. The range of **Line Debouncer Time** is from 0  $\mu$ s to 1000000  $\mu$ s.

---

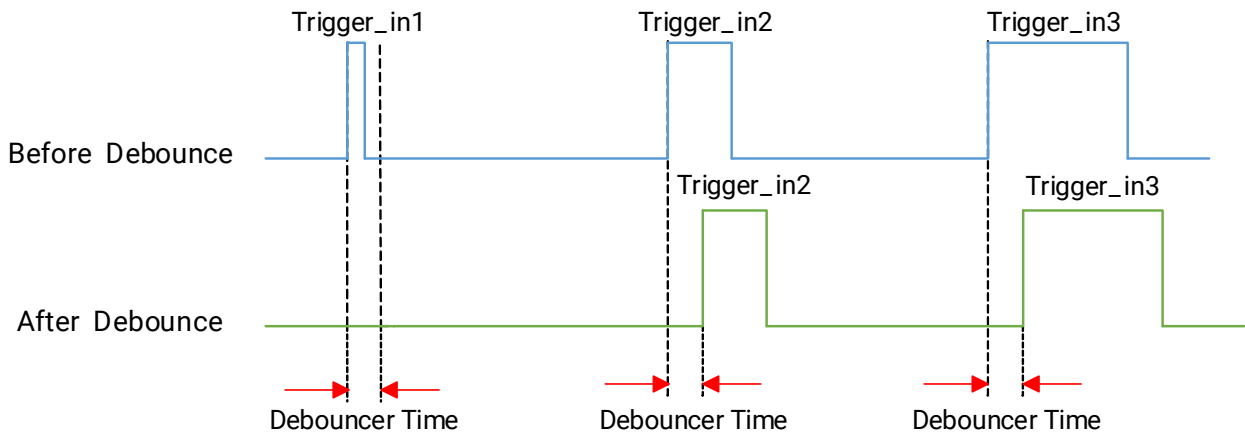
### Note

If the **Line Debouncer Time** you set is greater than the time of trigger signal, this trigger signal will be ignored.

---



**Figure 8-19 Set Trigger Debouncer**



**Figure 8-20 Sequence Diagram of Trigger Debouncer**

### Note

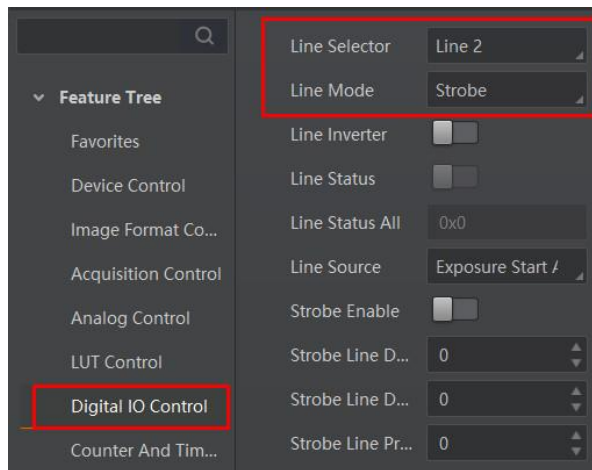
The sequence diagram above uses rising edge as trigger activation.

## 8.2 Trigger Output

The device has one opto-isolated output (Line 1), and one bi-directional I/O (Line 2) that can be configured as output signal. The steps for configuring Line 2 as output signal as follows.

### Steps

1. Go to **Digital IO Control** and select **Line 2** as **Line Selector**.
2. Select **Strobe** as **Line Mode**.

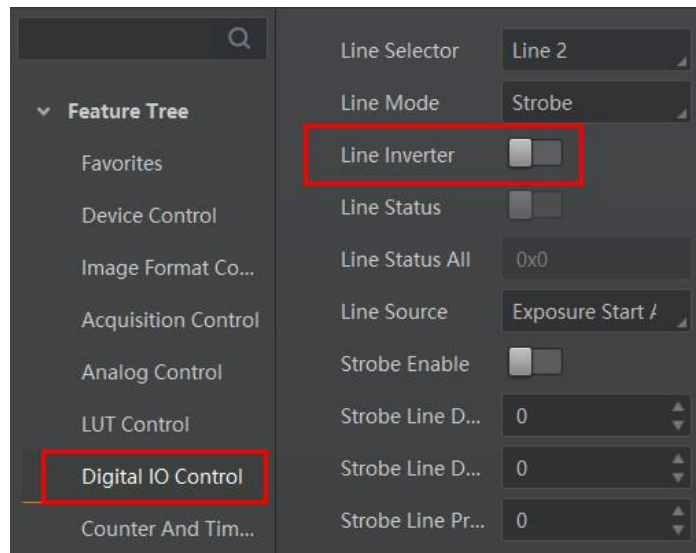


**Figure 8-21 Set Line 2 as Output Signal**

The output signal of the device is switch signal that can be used to control external devices such as light source, PLC, etc. There are two ways to set output signal, including line inverter and strobe signal.

## 8.2.1 Enable Line Inverter

The line inverter function allows the device to invert the electrical signal level of an I/O line. Go to **Digital IO Control** → **Line Inverter**, and enable it.



**Figure 8-22 Enable Line Inverter**

---

### Note

The line inverter function is disabled by default.

---

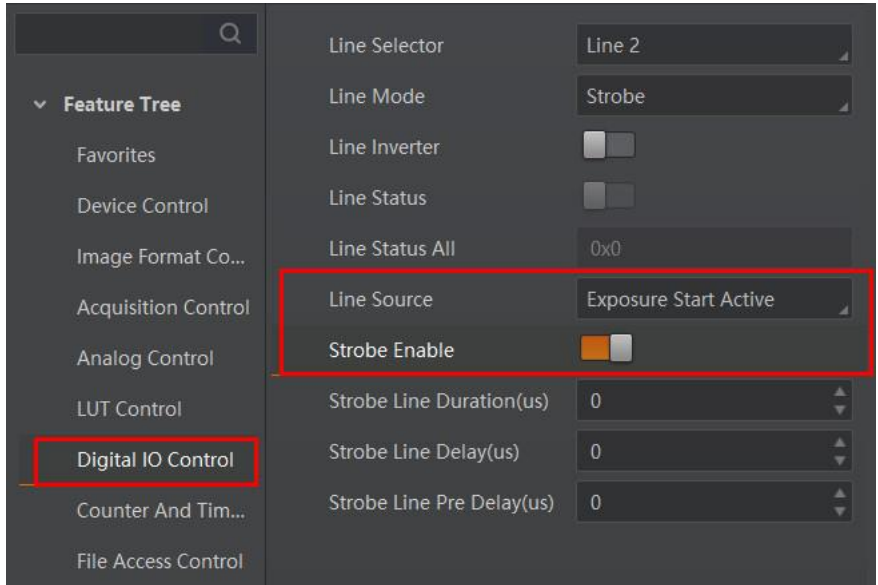
## 8.2.2 Enable Strobe Signal

The strobe signal is used to directly output I/O signal to external devices when the device's event source occurs.

### Steps

1. Go to **Digital IO Control** → **Line Source**, and select **Line Source** according to actual demands.
2. Enable **Strobe Enable**.





**Figure 8-23 Enable Strobe Signal**

The supported line sources are as follows:

**Table 8-4 Line Source Description**

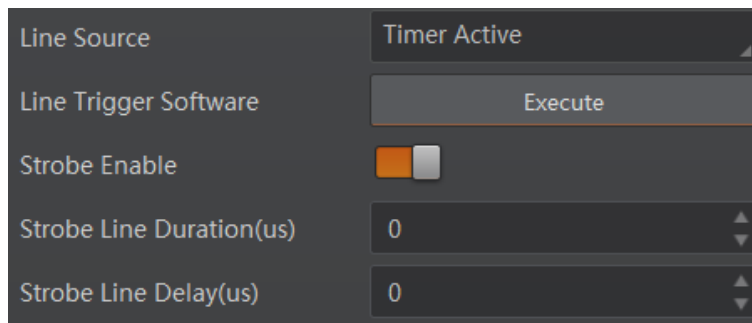
Line Source	Description
Exposure Start Active	The device outputs signals to external devices when it starts exposure.
Exposure End Active	The device outputs signals to external devices when it stops exposure.
Acquisition Start Active	The device outputs signals to external devices when it starts acquiring images.
Acquisition Stop Active	The device outputs signals to external devices when it stops acquiring images.
Frame Burst Start Active	The device outputs signals to external devices when the device's frame burst starts.
Frame Burst End Active	The device outputs signals to external devices when the device's frame burst stops.
Frame Trigger Wait	The device is currently waiting for a frame start trigger.
Frame Start Active	The device outputs signals to external devices when it starts doing the capture of a frame.
Frame End Active	The device outputs signals to external devices when it stops doing the capture of a frame.
Soft Trigger Active	The device outputs signals to external devices when it has a software trigger.

Line Source	Description
Hard Trigger Active	The device outputs signals to external devices when it has a hardware trigger.
Counter Active	The device outputs signals to external devices when it has a counter trigger.
Timer Active	The device outputs signals to external devices when it has a timer trigger.

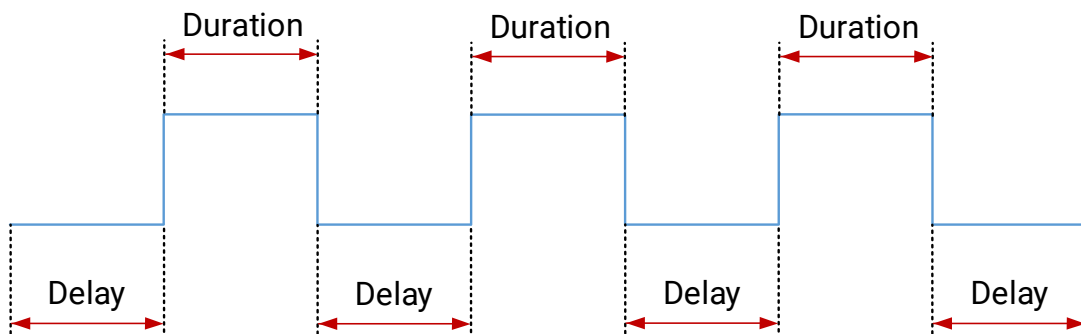
**Note**

The specific line sources may differ by device models.

If **Timer Active** is selected as **Line Source**, you can click **Execute** in **Line Trigger Software**, and enter **Strobe Line Delay** according to actual demands. The device will output signals whose duration is configured in **Strobe Line Duration**.



**Figure 8-24 Timer Active Parameters**



**Figure 8-25 Sequence Diagram of Timer Active**

### Set Strobe Line Duration

After enabling strobe signal, you can set its duration. Go to **Digital IO Control** → **Strobe Line Duration**, and enter it according to actual demands.

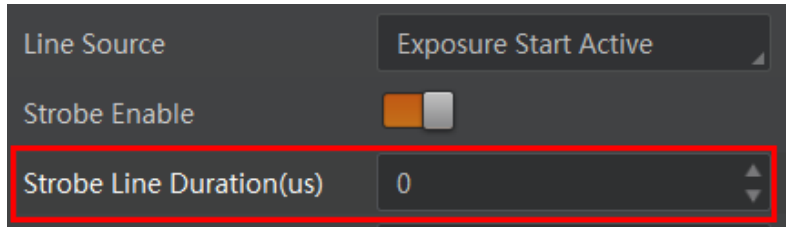


Figure 8-26 Set Strobe Line Duration

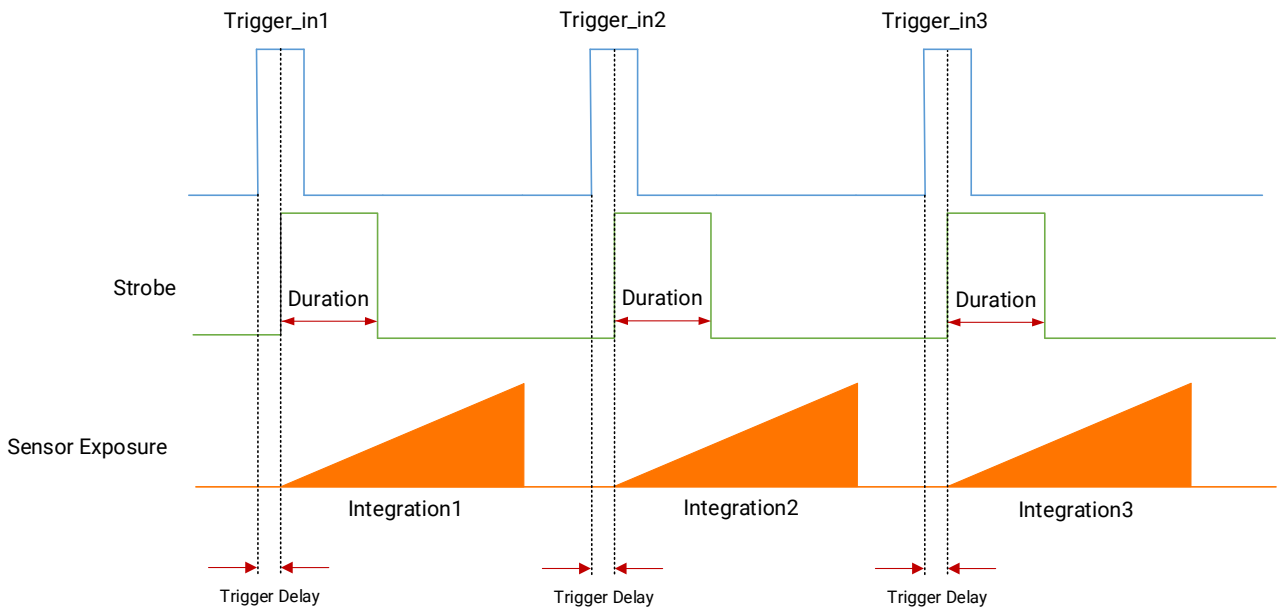


Figure 8-27 Sequence Diagram of Strobe Line Duration

**Note**

- When **Strobe Line Duration** value is 0, the strobe duration is equal to the exposure time.
- When **Strobe Line Duration** value is not 0, the strobe duration is the value you set.

### Set Strobe Line Delay

The strobe line delay function allows the device to output signal in a delay time. Go to **Digital IO Control** → **Strobe Line Delay**, and enter it according to actual demands. The range of **Strobe Line Delay** is from 0  $\mu$ s to 10000  $\mu$ s.

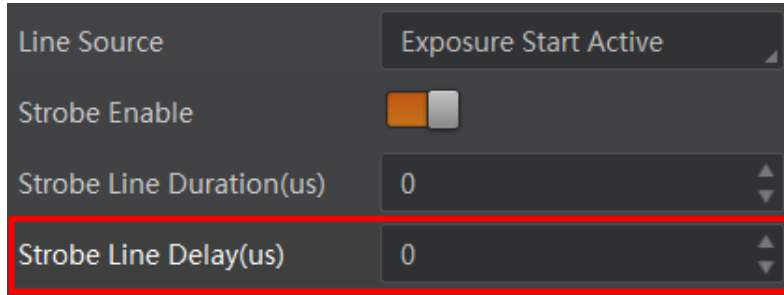


Figure 8-28 Set Strobe Line Delay

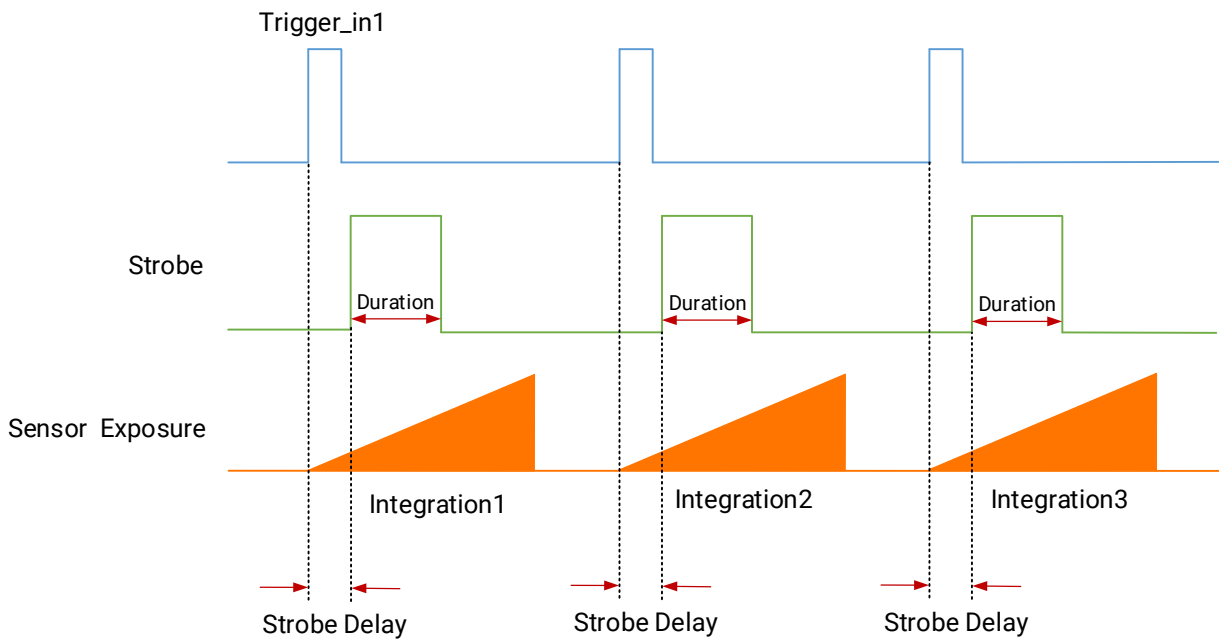
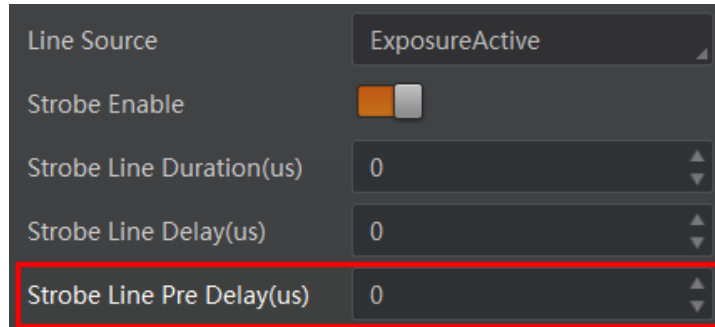


Figure 8-29 Sequence Diagram of Strobe Line Delay

### Set Strobe Line Pre Delay

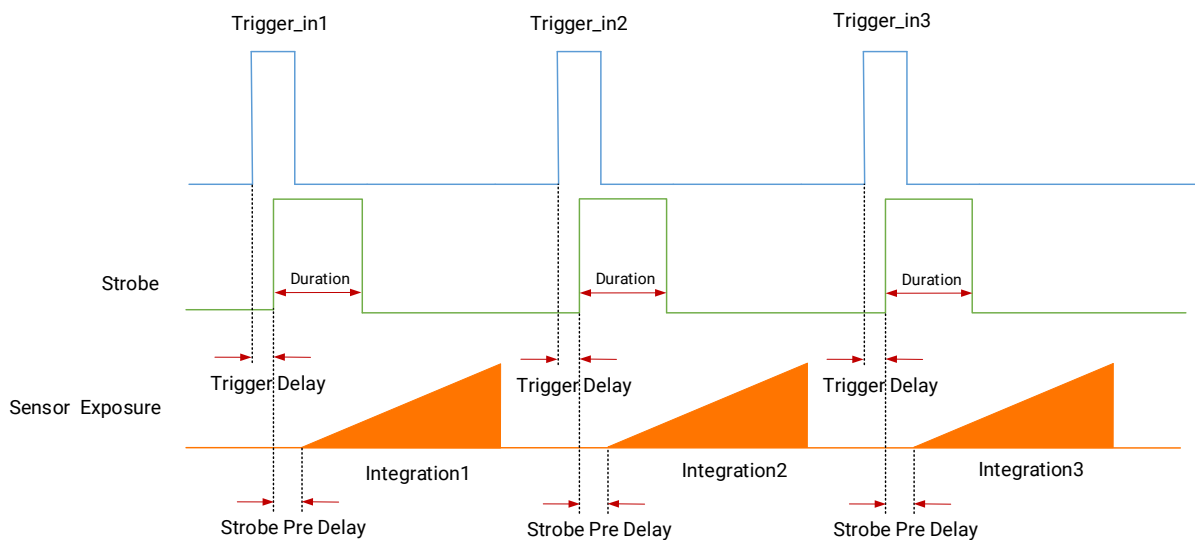
The device also supports the function of strobe line pre delay, which means that the strobe signal takes effect early than exposure. This function is applied to the external devices that have slow response speed.

Click **Digital IO Control** → **Strobe Line Pre Delay**, and enter **Strobe Line Pre Delay** according to actual demands.



**Figure 8-30 Set Strobe Pre Line Delay**

The sequence diagram of strobe line pre delay is shown below.



**Figure 8-31 Sequence Diagram of Strobe Pre Line Delay**

## Chapter 9 Image Acquisition

### 9.1 Global Shutter and Rolling Shutter

The shutter mode of the device is divided into global shutter and rolling shutter. The shutter mode is determined by the characteristics of the sensor used by the device.

#### 9.1.1 Global Shutter

For device that supports global shutter, its exposure starts and ends in each line simultaneously. After the exposure, data readout starts line by line. All pixels expose at the same time, then readout at different time.

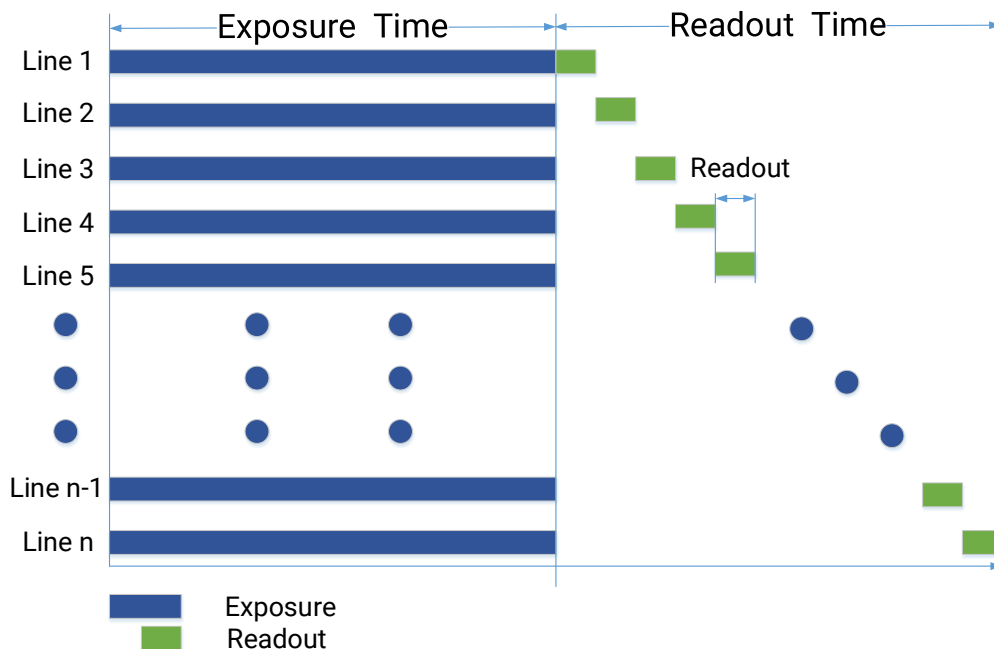


Figure 9-1 Global Shutter

#### 9.1.2 Rolling Shutter

##### Working Principle

For device that supports rolling shutter, as soon as the exposure ends, the data readout starts simultaneously. After the whole action, the rest of rows start to expose and read out one by one. All pixels expose at the same time, then readout at different time.

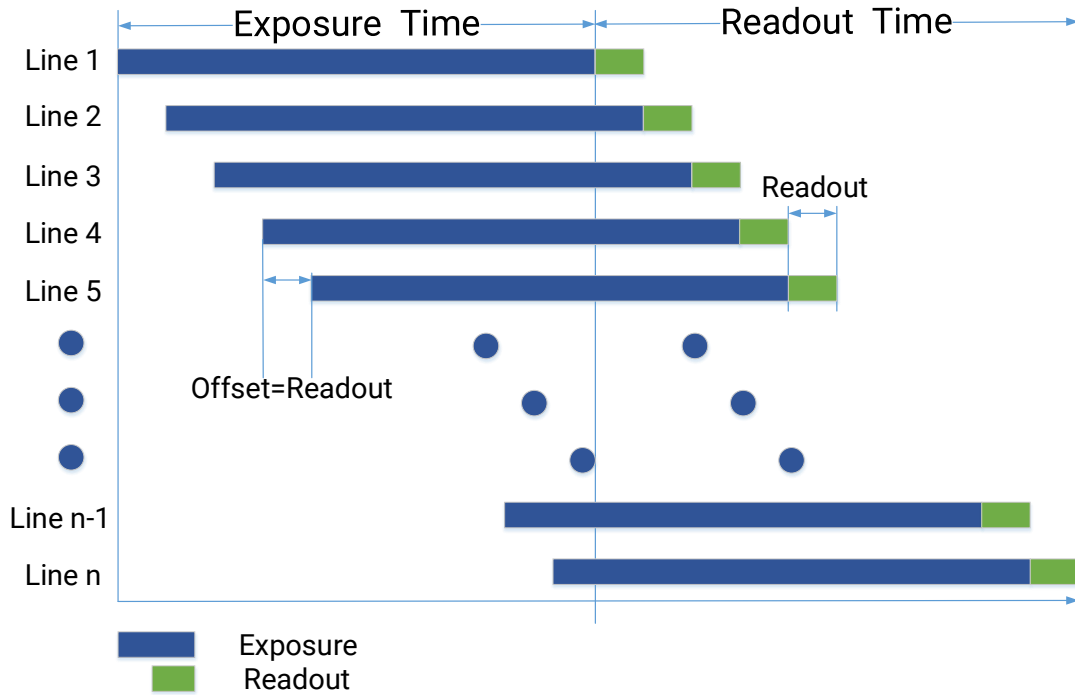


Figure 9-2 Rolling Shutter

### Global Reset

Global reset means that all of the sensor's pixels start exposing at the same time, but stop exposing at different time.

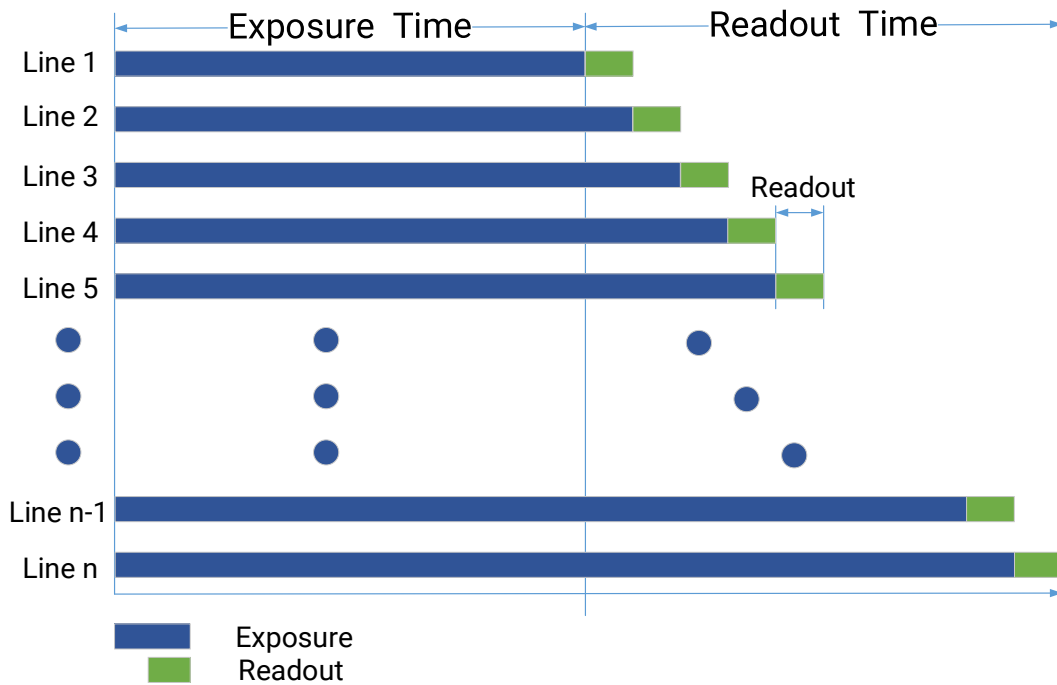
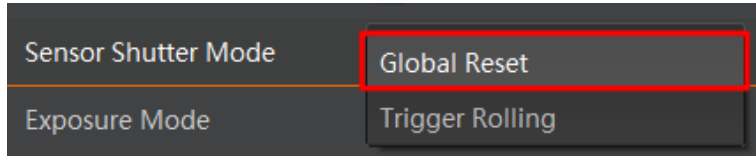


Figure 9-3 Global Reset

You can go to **Acquisition Control** → **Sensor Shutter Mode**, and select **Sensor Shutter Mode** according to actual demands.



**Figure 9-4 Select Global Reset**

---

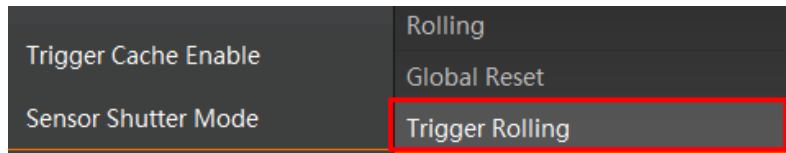
### Note

- Only some models of devices with rolling shutter and corresponding firmware support the sensor shutter mode. The actual product you purchased should prevail.
  - Stopping the real-time acquisition is required before setting the sensor shutter mode.
  - For some device models, only when **Trigger Mode** is **On**, you can set **Sensor Shutter Mode**.
- 

## Trigger Rolling

Rolling means that the device exposes the pixel rows one after the other, and it supports sensor's pixels exposure and pixel data readout proceeding at the same time. While trigger rolling does not support that sensor's pixels exposure and pixel data readout proceed at the same time.

You can go to **Acquisition Control** → **Sensor Shutter Mode**, and select **Sensor Shutter Mode** according to actual demands.



**Figure 9-5 Select Trigger Rolling**

---

### Note

The trigger rolling function may differ by device models.

---

## 9.2 Set Acquisition Mode

The device supports two types of acquisition modes, including **SingleFrame** mode and **Continuous** mode. Go to **Acquisition Control** → **Acquisition Mode**, and select **Continuous** or **SingleFrame** as **Acquisition Mode** according to actual demands.

- **SingleFrame**: When device starts image acquisition, it acquires one image only, and then stops.
  - **Continuous**: When device starts image acquisition, it acquires images continuously.
-



Real-time frame rate decides the acquisition frame number per second. You can stop image acquisition manually.

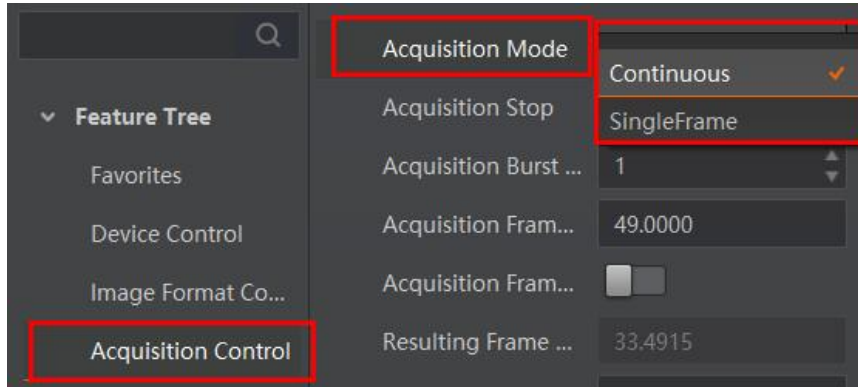


Figure 9-6 Set Acquisition Mode

## 9.3 Non-Overlap Exposure and Overlap Exposure

The process that the device captures one frame of image includes two stages, exposure and readout. According to the overlap relation between the exposure time and the readout time, devices with different sensors can be divided into overlap exposure and non-overlap exposure.

The device's overlap function is controlled by the overlap mode. Go to **Acquisition Control** → **Overlap Mode**, select **On** as **Overlap Mode** to have overlap exposure, and select **Off** as **Overlap Mode** to have non-overlap exposure.

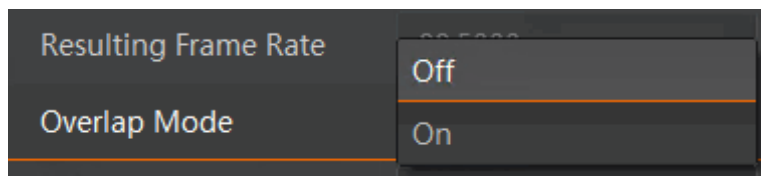


Figure 9-7 Set Overlap Mode

---

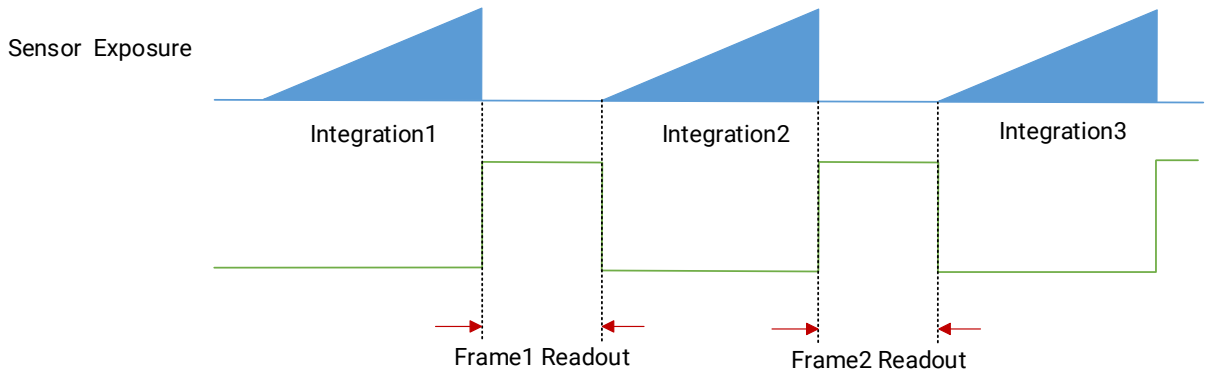
### Note

The overlap mode function may differ by device models.

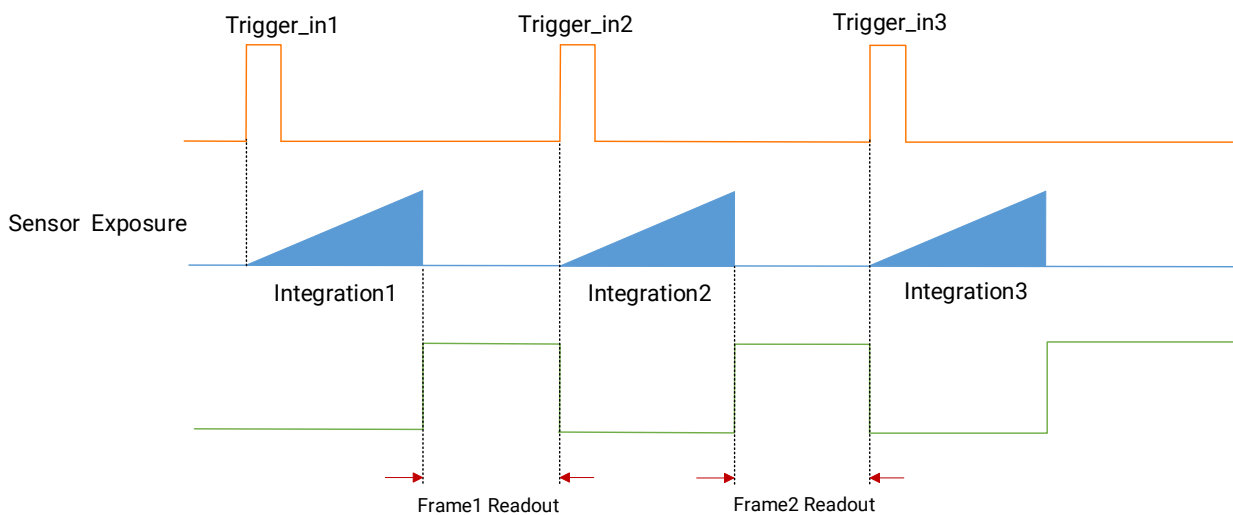
---

### 9.3.1 Non-Overlap Exposure

After completing the current frame’s exposure and readout, the next frame starts to expose and read out. This process is called non-overlap exposure. The non-overlap exposure’s frame period is larger than the sum of the exposure time and the readout time, as shown below.



**Figure 9-8 Internal Trigger Non-Overlap Exposure**



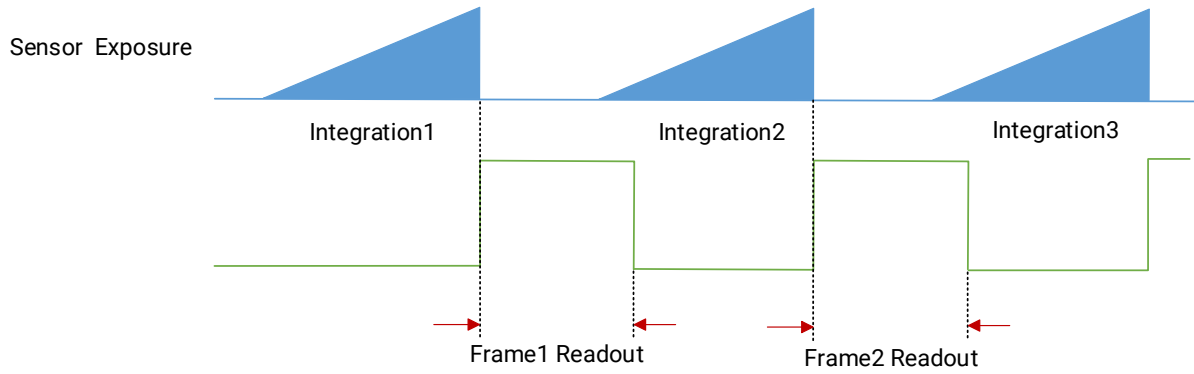
**Figure 9-9 External Trigger Non-Overlap Exposure**

**Note**

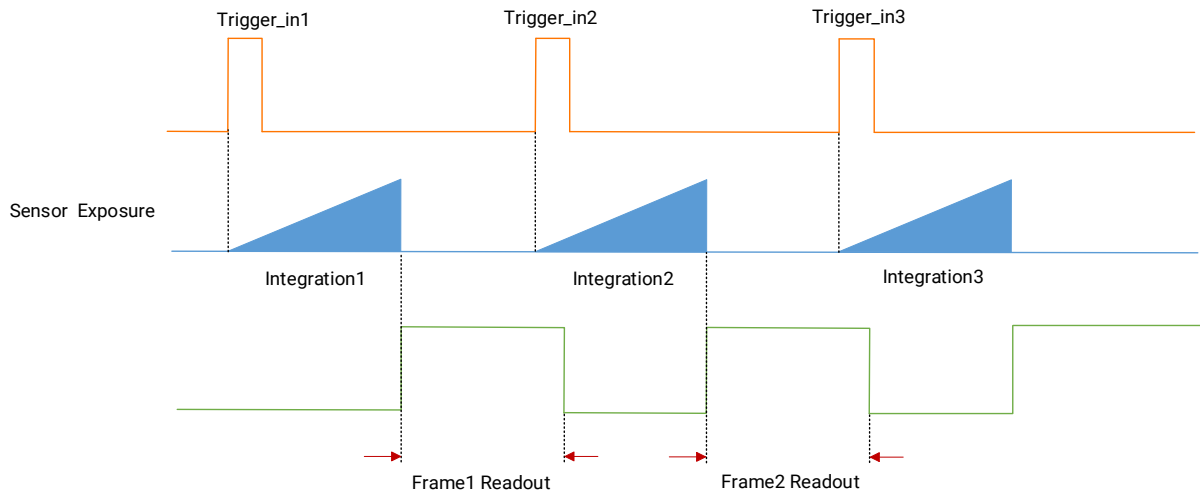
The device will ignore the external signal in the readout section under this mode.

### 9.3.2 Overlap Exposure

Overlap exposure refers to the overlap between the current frame exposure and the previous frame readout. In other words, when the previous frame starts to read out, the current frame starts to expose simultaneously, as shown below.



**Figure 9-10 Internal Trigger Overlap Exposure**



**Figure 9-11 External Trigger Overlap Exposure**

# Chapter 10 Image Transmission

## 10.1 Set Frame Rate

 **Note**

The image compression function may differ by device models

Frame rate refers to the image number that is acquired by the device per second. The higher frame rate, and shorter time used for image acquisition will be. The following five factors determine the device's frame rate in real-time.

- Frame readout time: The frame readout time is related with device's sensor performance and image height. The lower the image height and less the frame readout time, and the higher the frame rate will be.
- Exposure time: If the reciprocal of max. frame rate that the device supports is  $t$ , and when the configured exposure time is larger than  $t$ , the less the exposure time, the higher the frame rate will be. When the configured exposure time is less than or equal to  $t$ , exposure time will not influence the frame rate.
- Bandwidth: The larger the bandwidth, the higher the frame rate will be.
- Pixel format: The more bytes pixel format occupy, the lower the frame rate will be.
- Image compression mode: This function is used to compress data before transmitting to the PC, and increase the frame rate to some extent.

**Steps**

1. Go to **Acquisition Control** → **Acquisition Frame Rate**, and enter **Acquisition Frame Rate**.
2. Enable **Acquisition Frame Rate Control Enable**.

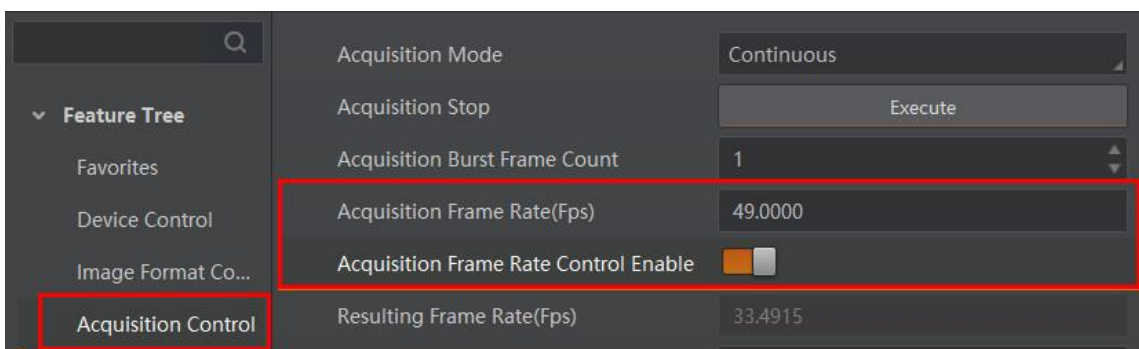


Figure 10-1 Set Frame Rate

**Note**

- If the real-time frame rate is smaller than the value you set, the device acquires images by the real-time frame rate.
- If the real-time frame rate is larger than the value you set, the device acquires images by the value you set.

3. View the device's final frame rate in **Resulting Frame Rate**.

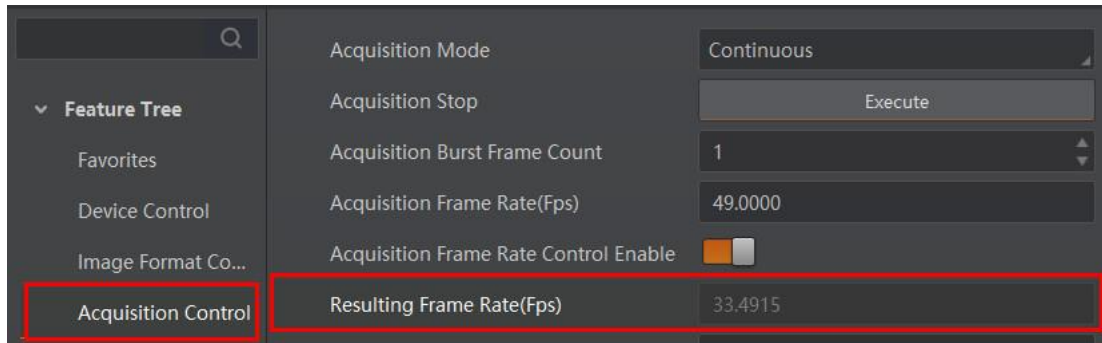


Figure 10-2 View Resulting Frame Rate

## 10.2 Set Full Frame Transmission

**Note**

The full frame transmission function may differ by device models.

The full frame transmission function is used to continue frame transmission action and have a full frame when frame acquisition stops during the process, and the frame will be discarded if this parameter is not enabled.

Go to **Acquisition Control** → **Full Frame Transmission**, and enable it according to actual demands.

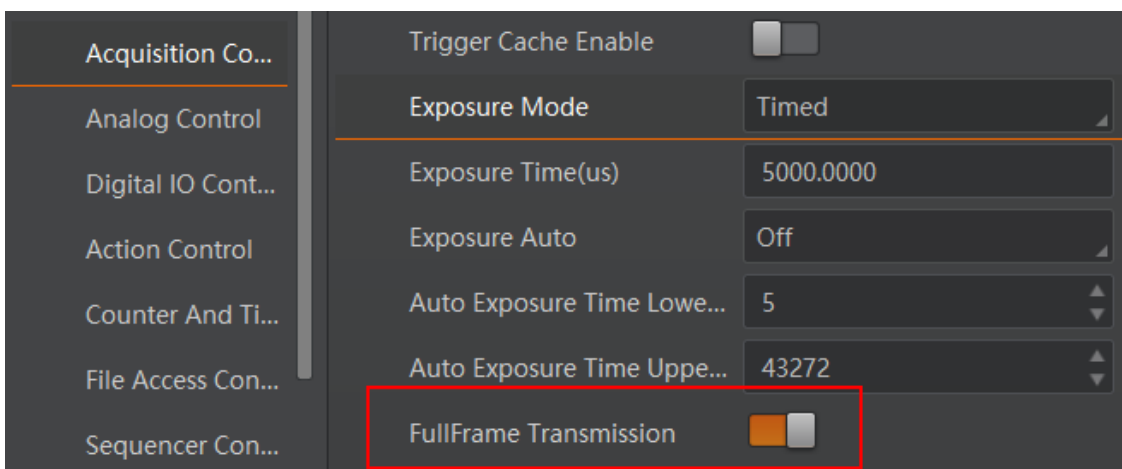


Figure 10-3 Set Full Frame Transmission

## 10.3 Set Packet Size

Packet size refers to the network packet size (in bytes) of the device to transmit stream channel data to the host. The total length, including the IP header, UDP header, and GVSP header, is 36 bytes, so the payload in a stream channel network packet is 1464 bytes by default. You can set it via **GEV SCPS Packet Size(B)** of **Transport Layer Control**, and it is recommended to set as 8164 bytes to improve network transmission performance.



Figure 10-4 Set Packet Size

---

### Note

- If the packet size is larger than 1500, network devices such as NICs and switches are required to support jumbo frames.
  - When changing the packet size, the two parameters of packet size and packet interval will jointly affect the network transmission performance.
-

## 10.4 Set Reserved Bandwidth

The reserved bandwidth is used to reserve a portion of the bandwidth for packet retransmission and control data transmission between the device and the host, and can also be used for multi-machine transmission when allocating limited bandwidth per device. For example, if the network bandwidth value is 1 Gbps and the reserved bandwidth value is configured to 20%, the device will calculate the frame rate at the maximum of 0.8 Gbps. The device's reserved bandwidth can be set via **Bandwidth Reserve** of **Transport Layer Control**, and the unit is %.

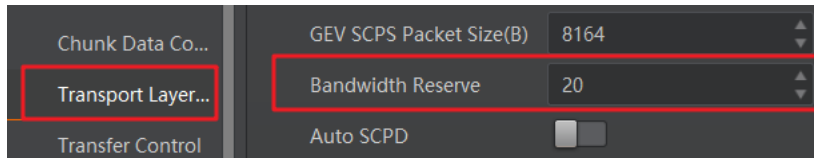


Figure 10-5 Set Reserved Bandwidth

## 10.5 Set Packet Interval

The packet interval is used to control the bandwidth over which the device transmits image stream data. The packet interval is the number of idle clocks inserted between adjacent network packets transmitted by a stream channel. Increasing the packet interval can reduce the device's utilization of network bandwidth, and may also reduce the device's frame rate.

The device's packet size, packet interval, and reserved bandwidth settings determine the effective network bandwidth. The effective network bandwidth is calculated as follows:

Time required to transmit a single stream datagram:

$$T_{data} = (Size_{pkt} \times 8bits) / Speed_{link}$$

Packet delay time:

$$T_{delay} = Delay_{pkt} / 125000000$$

Packet size:  $Size_{pkt}$ , packet interval:  $Delay_{pkt}$ , reserved bandwidth  $BandW_{reserve}$ , and link speed  $Speed_{link}$

Effective network bandwidth:

$$BandW_{avail} = \left( \frac{Size_{pkt} \times 8bits}{T_{data} + T_{delay}} \right) \times \frac{(100 - BandW_{reserve})}{100}$$

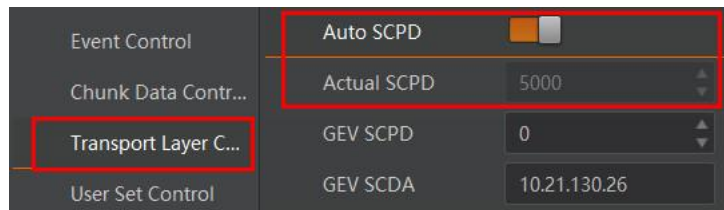
Figure 10-6 Effective Network Bandwidth

You can set the device's packet interval via **GEV SCPD** of **Transport Layer Control**.



**Figure 10-7 Set GEV SCPD**

You can also enable **Auto SCPD** to let the client software automatically adjust SCPD value and optimize data transmission process. The device's actual SCPD value is displayed in **Actual SCPD**.

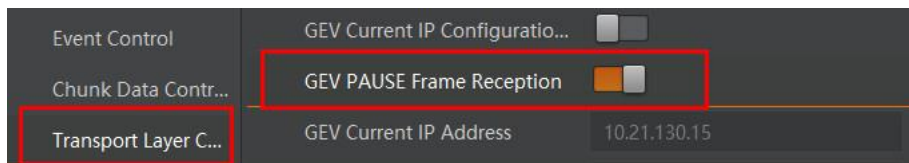


**Figure 10-8 Auto SCPD**

## 10.6 Set Pause Frame

The pause frame is used to control the amount of image stream data transmitted by the device. When the host receives too much image stream data, a part of the transmitted frames will be discarded by the host. Therefore, the pause frame may be used for flow control. When the device receives the pause frame sent by the host, the device slows down the transmission rate.

The received pause frame can be processed by enabling **GEV PAUSE Frame Reception** of **Transport Layer Control**, as shown below.



**Figure 10-9 Set Pause Frame**



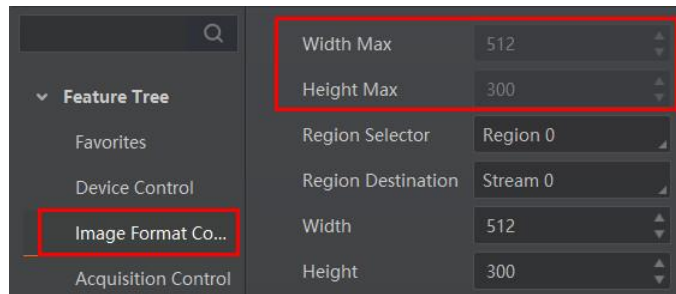
# Chapter 11 Basic Functions

## 11.1 View Resolution and ROI

**Note**

The device displays the image with max. resolution by default.

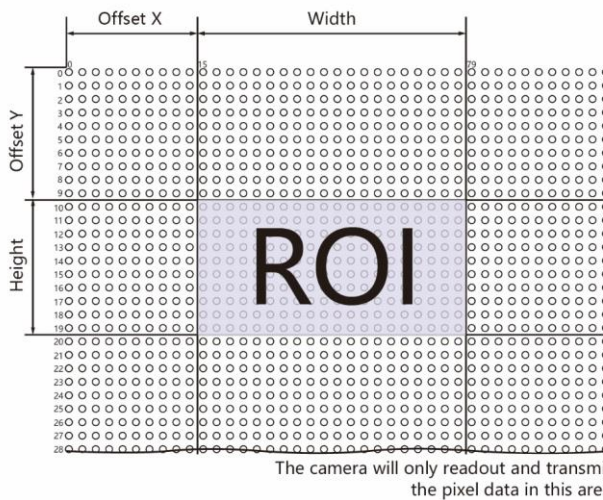
Go to **Image Format Control**, and you can view resolution by reading **Width Max** and **Height Max**. **Width Max** stands for the max. pixels per inch in width direction, and **Height Max** stands for the max. pixels per inch in height direction.



**Figure 11-1 View Resolution**

If you are only interested in a certain region of the image, you can set a Region of Interest (ROI) for the device.

When the user is only interested in some details in the image, image cropping is needed. That is, an ROI setting is performed on the device to output an image of the region of interest. Setting the region of interest can reduce the transmission data bandwidth and improve the device's frame rate to a certain extent.



**Figure 11-2 ROI**

**Note**

- Region of interest can be set only when you stop real-time acquisition.
- The device currently supports one ROI only, and you can select **Region 0** as **Region Selector**.
- The **Width** plus **Offset X** should not be larger than **Width Max**, and **Height** plus **Offset Y** should not be larger than **Height Max**.

Go to **Image Format Control** → **Region Selector**, and enter **Width**, **Height**, **Offset X**, and **Offset Y**.

- **Width**: It stands for horizontal resolution in ROI area.
- **Height**: It stands for vertical resolution in ROI area.
- **Offset X**: It refers to the horizontal coordinate of the upper left corner of the ROI.
- **Offset Y**: It refers to the vertical coordinate of the upper left corner of the ROI.



Figure 11-3 Set ROI

## 11.2 Set Image Reverse

**Note**

For different models of device, the image reverse function may be different, please refer to the actual one you got.

**Reverse X** refers to the image reverses in a horizontal way, and **Reverse Y** refers to the image reverses in a vertical way.

You can click **Image Format Control**, and enable **Reverse X** or **Reverse Y** according to actual demands.



Figure 11-4 Set Image Reverse

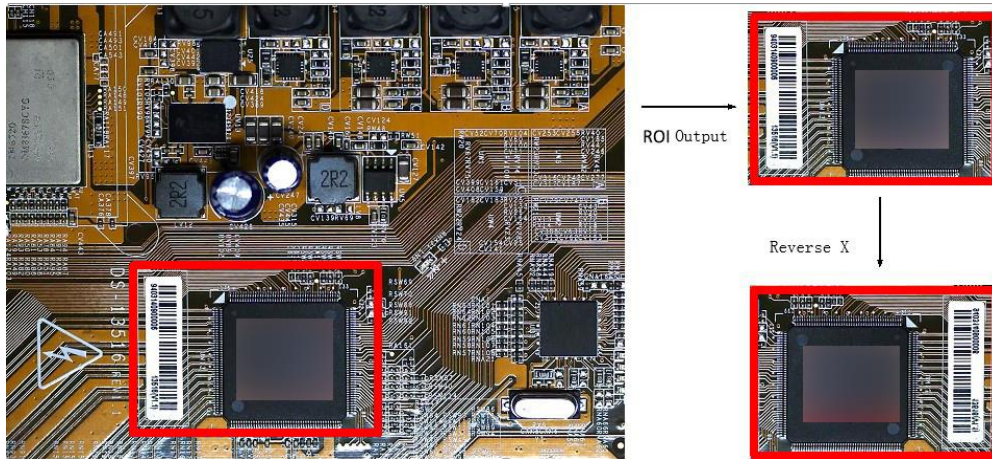


Figure 11-5 Image Reverse Comparison

### 11.3 Set Pixel Format

This function allows you to set the pixel format of the image data transmitted by the device. Go to **Image Format Control** → **Pixel Format**, and set **Pixel Format** according to actual demands.

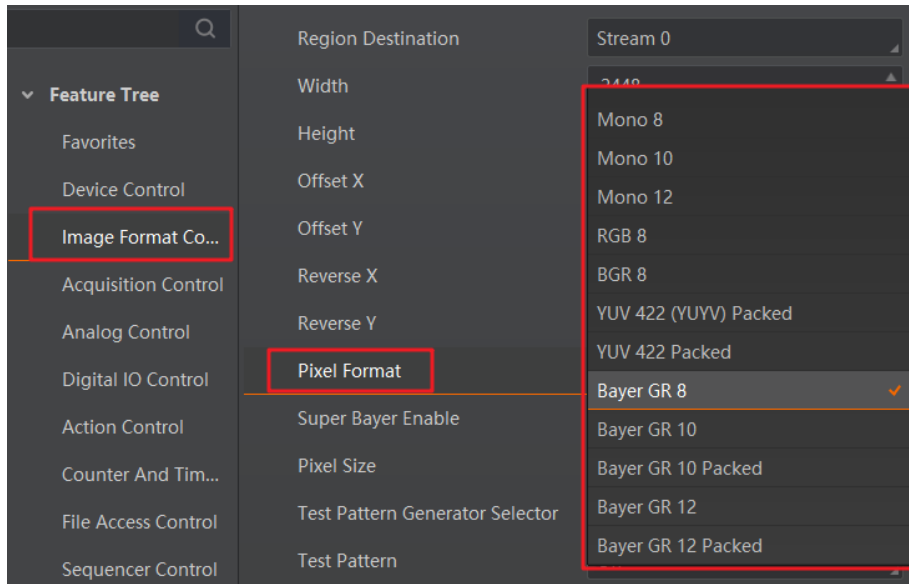
**Note**

- The specific pixel formats may differ by device models.
- With different ADC bit depth, the pixel format and pixel size may differ.

Table 11-1 Pixel Format and Pixel Size

ADC Bit Depth	Pixel Format	Pixel Size (Bits/Pixel)
8	Mono 8, Bayer 8	8
	Mono 10 Packed, Mono 12 Packed, Bayer 10 Packed, Bayer 12 Packed	12
	Mono 10/12 , Bayer 10/12, YUV422Packed, YUV 422 (YUYV) Packed	16
	RGB 8, BGR 8	24
10	Mono 8, Bayer GB 8	8
	Mono 10 Packed, Mono 12 Packed, Bayer GB 10 Packed, Bayer GB 12 Packed	12
	Mono 10/12, Bayer GB 10/12, YUV422Packed, YUV 422 (YUYV) Packed	16
	RGB 8, BGR 8	24

ADC Bit Depth	Pixel Format	Pixel Size (Bits/Pixel)
12	Mono 8, Bayer 8	8
	Mono10 Packed, Mono 12 packed, Bayer 10 Packed, Bayer 12 Packed	12
	Mono 10/12, Bayer 10/12, YUV422Packed, YUV 422 (YUYV) Packed	16
	RGB 8, BGR 8	24



**Figure 11-6 Set Pixel Format**

With different ADC bit depths and pixel formats, the device’s max. frame rate may differ. The larger the device’s ADC bit depth value, the better the device’s image quality, the lower the device’s frame rate will be.

**Note**

The ADC bit depth function may differ by device models.

The default output data format of mono device is Mono 8. The default output data format of color device is Bayer 8, and it can be converted into RGB format via pixel interpolation algorithm. Bayer GR, Bayer GB, Bayer BG, Bayer RG and Bayer RBGG patterns are shown below.



**Figure 11-7 Bayer GR Pixel Pattern**



Figure 11-8 Bayer GB Pixel Pattern



Figure 11-9 Bayer BG Pixel Pattern



Figure 11-10 Bayer RG Pixel Pattern

In Bayer pixel format, some color devices support Gamma function, LUT, contrast ratio, super palette control, and sharpness function after you enable **Super Bayer Enable**. Go to **Image Format Control** → **Super Bayer Enable**, and enable it according to actual demands.

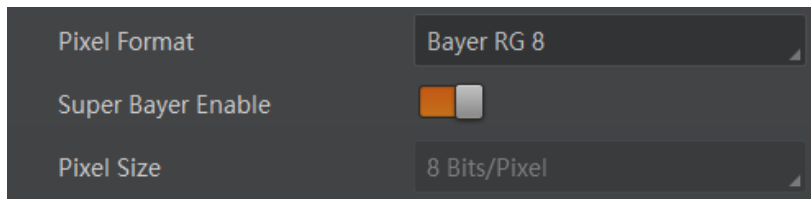


Figure 11-11 Set Super Bayer

---

**Note**

For different models of device, the super Bayer function may be different, please refer to the actual one you got.

---

## 11.4 Set Image Compression Mode

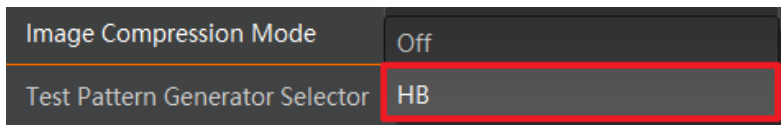
**Note**

The function of the image compression is related with device models, firmware and pixel format, and the actual product you purchased should prevail.

Without affecting image quality, this function allows the device to compress data before transmitting to the external devices, and lower the usage of bandwidth.

**Steps**

1. Go to **Image Format Control** → **Image Compression Mode**.
2. Select **HB** as **Image Compression Mode**.

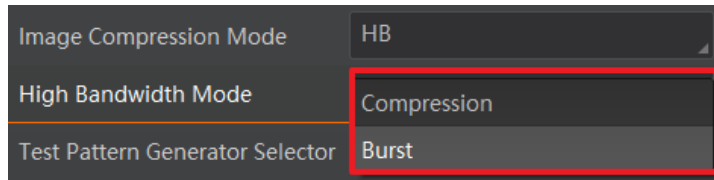


**Figure 11-12 Set Image Compression Mode**

3. Select **Compression** or **Burst** as **High Bandwidth Mode** according to actual demands.

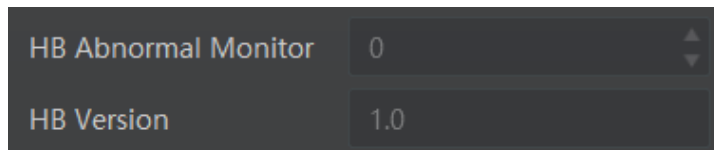
**Note**

**Compression** only compresses the image data, while **Burst** compresses the image data and increases the frame rate.



**Figure 11-13 Set High Bandwidth Mode**

4. (Optional) View the image compression mode's related parameters like **HB Abnormal Monitor** and **HB Version** in the **Device Control** attribute.



**Figure 11-14 HB Abnormal Monitor and Version**

- HB abnormal monitor is used to monitor image stream condition. If the size of compressed image is larger than that of raw image under HB function, this parameter will increase. When this parameter increases rapidly, it is recommended to disable the image compression mode.
- HB version refers to the version of this function.

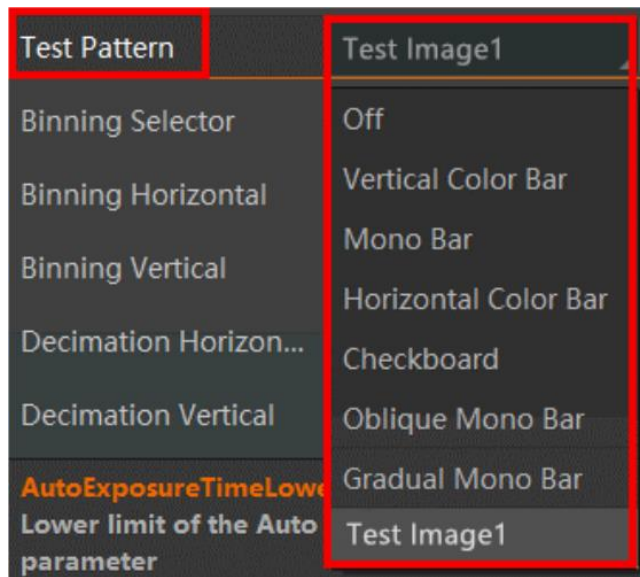
## 11.5 Set Test Pattern

**Note**

The test pattern may differ by device models.

The device supports test pattern function. When there is exception in real-time image, you can check whether image of test mode have similar problem to determine the reason. This function is disabled by default, and at this point, the outputted image by the device is real-time image. If this function is enabled, the outputted image by the device is test image.

Go to **Image Format Control** → **Test Pattern Generator Selector** → **Test Pattern**, and set **Test Pattern** according to actual demands.



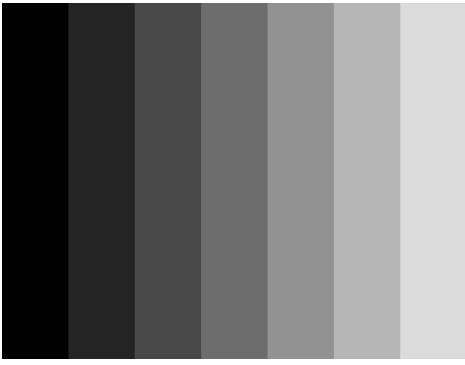
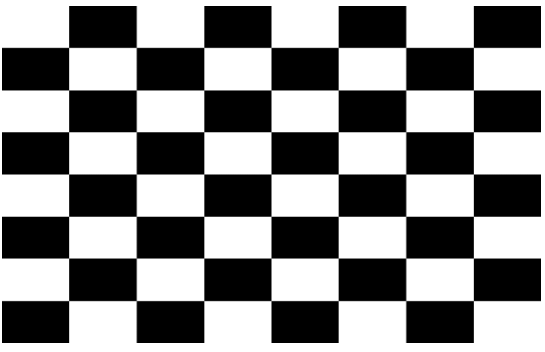
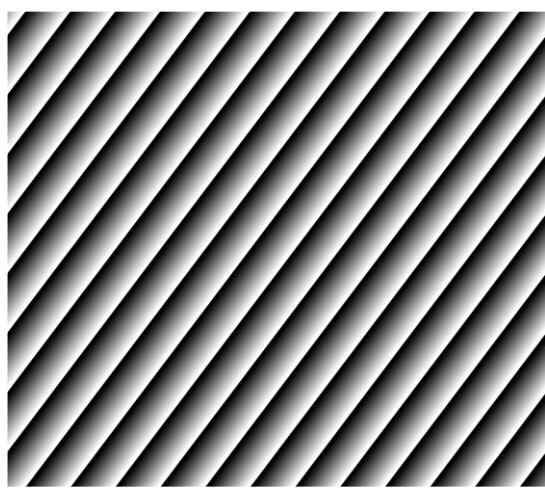

**Figure 11-15 Set Test Pattern**

The mono device offers 5 test patterns, including **Mono Bar**, **Checkboard**, **Oblique Mono Bar**, **Gradual Mono Bar**, and **Test Image 1**.

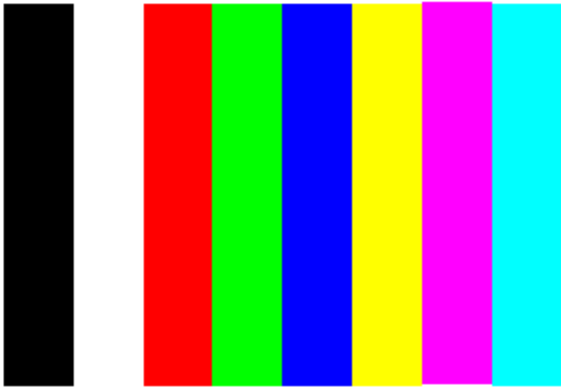

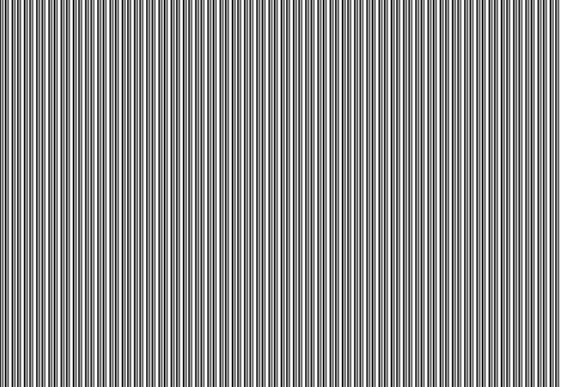
The color device offers 7 test patterns, including **Mono Bar**, **Checkboard**, **Oblique Mono Bar**, **Gradual Mono Bar**, **Vertical Color Bar**, **Horizontal Color Bar**, and **Test Image 1**.

**Table 11-2 Test Pattern**

Test Pattern	Image
--------------	-------

Test Pattern	Image
Mono Bar	
Checkboard	
Oblique Mono Bar	
Gradual Mono	



Test Pattern	Image
Vertical Color Bar	 <p>A vertical test pattern consisting of seven distinct vertical bars of color: black, red, green, blue, yellow, magenta, and cyan.</p>
Horizontal Color Bar	 <p>A horizontal test pattern consisting of seven distinct horizontal bars of color: black, red, green, blue, yellow, magenta, and cyan.</p>
Test Image	 <p>A test image consisting of a dense array of vertical black lines of varying thicknesses on a white background.</p>

**Note**

The pattern of the test image 1 may differ by device models.

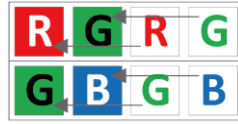
## 11.6 Set Binning

**Note**

- **Binning Horizontal** is the image's width, and **Binning Vertical** is the image's height.

- The binning related functions may differ by device models.

The purpose of setting binning is to enhance sensibility. With binning, multiple sensor pixels are combined as a single pixel to reduce resolution and improve image brightness. For a color device, it merges the pixel values of adjacent pixels of the same color horizontally, as shown below.



**Figure 11-16 Binning Horizontal 2**



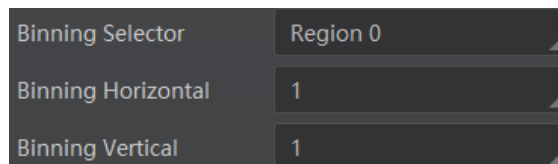
**Figure 11-17 Binning Vertical 2**

If the horizontal binning coefficient and the vertical binning coefficient of the color device are both configured to 2, the device merges the 4 adjacent sub-pixels of the same color according to the corresponding position, and outputs the merged pixel value as a sub-pixel, as shown below.



**Figure 11-18 Binning Horizontal 2 and Binning Vertical 2**

Click **Binning Selector**, and set **Binning Horizontal** and **Binning Vertical** according to actual demands.



**Figure 11-19 Set Binning**

The device also supports binning mode function if the binning is  $2 \times 2$  and above. The binning mode defines how pixels are combined if the binning is  $2 \times 2$  and above. Click **Binning Mode**, and select **Sum** or **Average** according to actual demands.

- **Sum**: The values of the affected pixels are summed. This improves the signal-to-noise ratio, but also increases the device's response to light.
- **Average**: The values of the affected pixels are averaged. This greatly improves the signal-to-noise ratio without affecting the device's response to light.

Both binning modes (Sum and Average) reduce the amount of image data to be transferred.

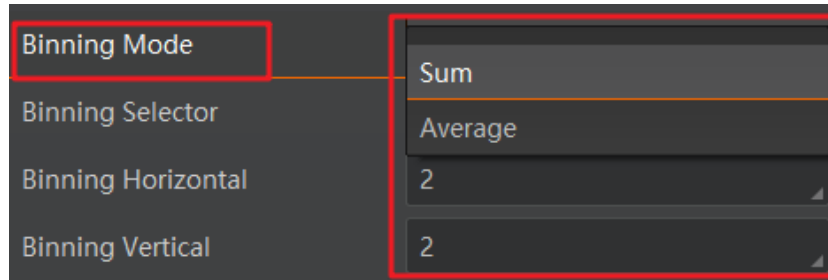


Figure 11-20 Set Binning Mode

---

### Note

Configuring binning mode is supported when the device is acquiring images.

---

## 11.7 Set Decimation

---

### Note

- **Decimation Horizontal** is the image's width, and **Decimation Vertical** is the image's height.
- The decimation related functions may differ by device models.

The decimation feature allows you to reduce the number of sensor pixel columns or rows that are transmitted by the device. This procedure is also known as subsampling. It reduces the amount of data to be transferred and may increase the device's frame rate. Click **Image Format Control**, and set **Decimation Horizontal** and **Decimation Vertical** according to actual demands.

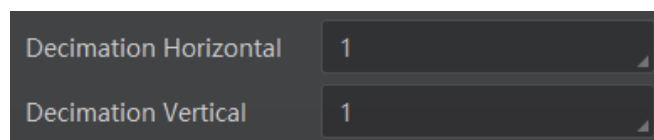


Figure 11-21 Set Decimation

## 11.8 Set Exposure Mode

### Note

The exposure mode may differ by device models.

The device supports 2 types of exposure modes, including **Timed** and **Trigger Width**.

- If the **Exposure Mode** is **Timed**, the device's exposure time is controlled by **Exposure Auto** and **Exposure Time**.
- When the device's **Trigger Mode** is **On**, **Trigger Source** is **Line 0** or **Line 2**, and **Trigger Activation** is **Level High** or **Level Low**, **Trigger Width** can be selected as **Exposure Mode** and the device's exposure time is controlled by the signal duration.

### Note

Only when the **Trigger Mode** is **On**, **Trigger Source** is **Line 0** or **Line 2**, and **Trigger Activation** is **Level High** or **Level Low**, **Trigger Width** can be selected as **Exposure Mode**.

The device offers 2 types of exposure time modes, including **Ultrashort** mode and **Standard** mode.

### 11.8.1 Set Ultrashort Mode

In ultrashort mode, the device takes very little exposure time, and the exposure time can only be adjusted manually. Because the exposure time is small, it needs to be used with the light source.

Go to **Acquisition Control** → **Exposure Time Mode**, and set **Exposure Time Mode** according to actual demands.

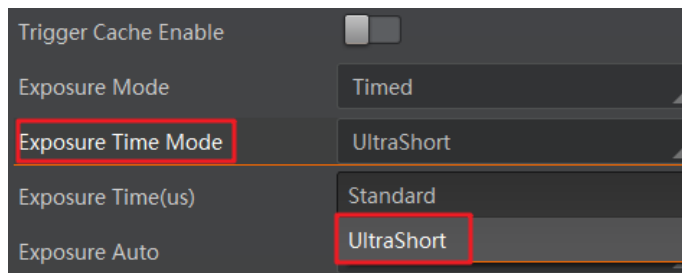


Figure 11-22 Set Ultrashort Mode

### Note

- The exposure time mode may differ by device models.
- If the device you got does not support **Ultrashort** exposure time mode, and then there is no **Exposure Time Mode** parameter, and your device supports **Standard** exposure time mode only by default.

## 11.8.2 Set Standard Mode

In standard mode, the device supports 3 types of exposure mode, including **Off**, **Once** and **Continuous**. Click **Acquisition Control** → **Exposure Auto**, and select **Exposure Auto** according to actual demands.

- **Off**: The device exposures according to the value set in **Exposure Time (μs)**.
- **Once**: The device adjusts the exposure time automatically according to the image brightness. After adjusting, it will switch to **Off** mode.
- **Continuous**: The device adjusts the exposure time continuously according to the image brightness.

When the exposure mode is set as **Once** or **Continuous**, the exposure time should be within the range of **Auto Exposure Time Lower Limit (μs)** and **Auto Exposure Time Upper Limit (μs)**.

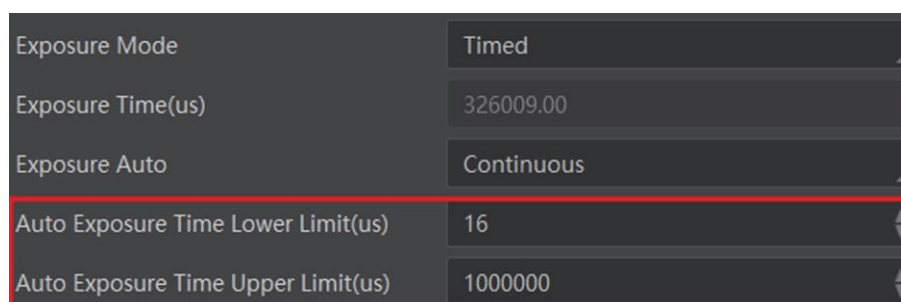


Figure 11-23 Set Exposure Time under Once or Continuous Mode

### Note

- If the device is under **Continuous** exposure mode, once external trigger mode is enabled, the device will automatically switch to **Off** exposure mode.
- Some models of the device do not support **Once** or **Continuous** exposure mode. You can enter **Exposure Time (μs)** directly.

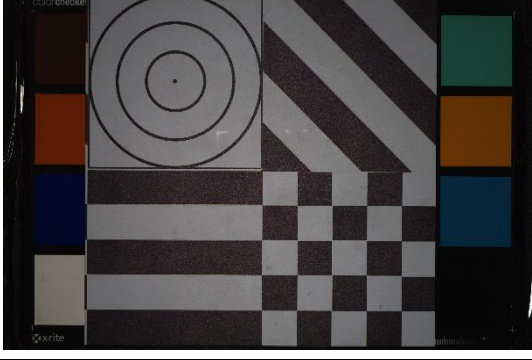
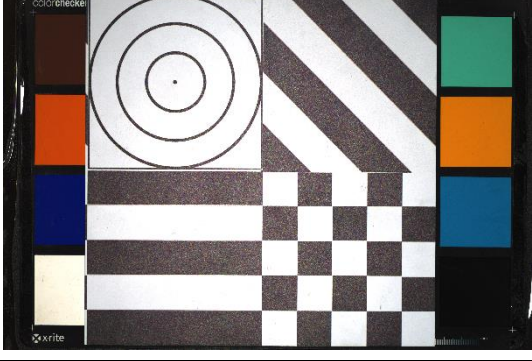
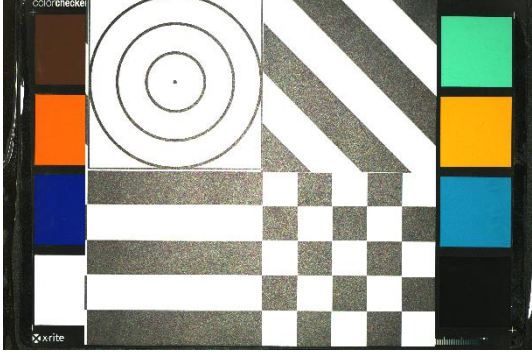
## 11.9 Set Brightness

The device brightness refers to the brightness when the device adjusts image under **Once** or **Continuous** exposure mode, or **Once** or **Continuous** gain mode.

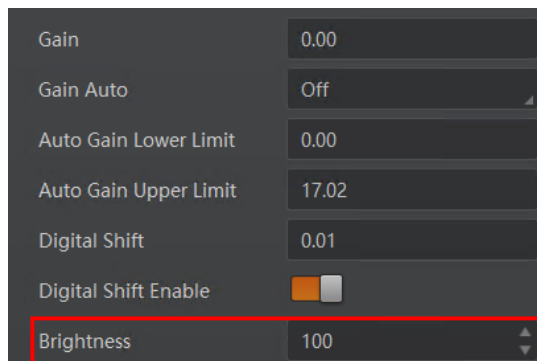
### Note

- You should enable **Once** or **Continuous** exposure mode, or **Once** or **Continuous** gain mode first before setting brightness.
- After setting brightness, the device will automatically adjust exposure time to let image brightness reach target one. Under **Once** or **Continuous** exposure mode, or **Once** or **Continuous** gain, the higher the brightness value, the brighter the image will be.

**Table 11-3 Brightness Example**

Brightness Value	Image
Brightness=25	
Brightness=75	
Brightness=120	

Go to **Analog Control** → **Brightness**, and enter **Brightness** according to actual demand.



**Figure 11-24 Set Brightness**

## 11.10 Set Sharpness

---

### Note

- The sharpness function may differ by device models.
  - The device supports sharpness function only in Mono and YUV formats.
  - Regarding the color device in Bayer pixel format, you need to enable **Super Bayer Enable** first before using sharpness function.
- 

The device supports sharpness function that can adjust the sharpness level of the image edge, You can set sharpness as shown below.

Go to **Analog Control** → **Sharpness Enable**, enable **Sharpness Enable**, and enter **Sharpness** according to actual demands.

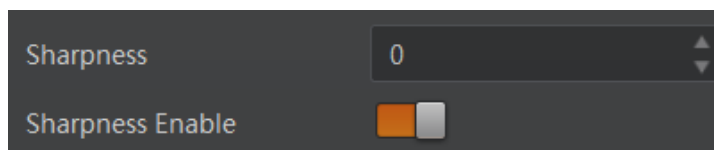


Figure 11-25 Set Sharpness

## 11.11 Set Contrast Ratio

---

### Note

- The contrast ratio function may differ by device models.
  - Make sure that the live view is enabled, and Gamma correction and LUT function is disabled before using the contrast ratio function.
  - Regarding the color device in Bayer pixel format, you need to enable **Super Bayer Enable** first before using contrast ratio function.
  - The range of **Contrast Ratio** is from 0 to 100.
- 

The device supports the contrast ratio function that adjusts the intensity of light and darkness and color. The larger the contrast ratio, and more clear the image is.

Go to **Analog Control**, enable **Contrast Ratio Enable**, and set **Contrast Ratio** according to actual demands.

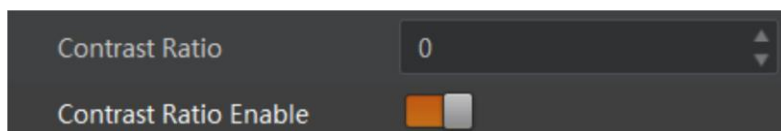


Figure 11-26 Set Contrast Ratio

## 11.12 Set White Balance

---

### Note

White balance is only available for color devices.

---

The white balance refers to the device color adjustment depending on different light sources. Adjust the R/G/B ratio to ensure that the white regions are white under different color temperatures. Ideally, the proportion of R/G/B in the white region is 1:1:1.

The device supports 3 types of white balance mode, including **Off**, **Once** and **Continuous**. Click **Analog Control** → **White Balance Auto**, and select **White Balance Auto** according to actual demands.

- **Off**: You need to set the R, G, B ratio manually via **Balance Ratio Selector** and **Balance Ratio**. The range is from 1 to 16376, and 1024 means ratio is 1.0.
- **Once**: Adjust the white balance for a certain amount of time then stop.
- **Continuous**: Adjust the white balance continuously.

It is recommended to correct white balance when there is great difference between the device's color effect and actual effect. You can correct white balance as shown below.

### Steps

1. Put a white paper in the range of the device's field of view, and make sure the paper covers the entire field of view.
  2. Set exposure and gain.
- 

### Note

It is recommended to set image brightness value between 120 and 160.

---

3. Select **Wide** as **AWB Color Temperature Mode** to let the device adjust white balance again if the image's color effect is not good under the default condition of **Balance White Auto** is **Continuous** and **AWB Color Temperature Mode** is **Narrow**.

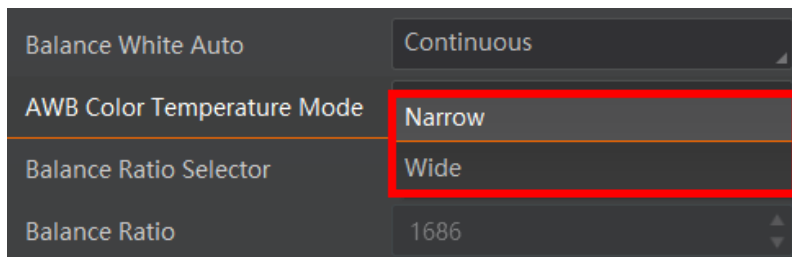


Figure 11-27 Set Parameters

If there is still great difference between correction effect and actual color, it is recommended to correct white balance according to following steps.



### Steps

---

#### Note

- Here we take **Green** as an example. For specific **Balance Ratio Selector** value, please refer to the actual condition.
  - In order to avoid repeated correction after rebooting the device, it is recommended to save white balance parameter to **User Set** after white balance correction. You can refer to the Section **Save and Load User Set** for details.
  - If the light source and color temperature in environment change, you need to correct white balance again.
- 

1. Select **Off** as **Balance White Auto**. At this time, **Balance Ratio** is 1024.
2. Find corresponding R/G/B channel in **Balance Ratio Selector**. Here we take **Green** as an example.
3. Find device's R/G/B value.
4. Take **Green** as correction standard, and manually adjust other two channels (R channel and B channel) to let these three channels have same value.

## 11.13 Set Sequencer Control and HDR

The device supports sequencer or HDR functions, which allow you to configure multiple groups of parameters to acquire images.

---

#### Note

- The device cannot support sequencer and HDR functions at the same time.
  - The sequencer or HDR function may differ by device models.
-

### 11.13.1 Set Sequencer

If the device supports sequencer, you can configure multiple groups of parameters including exposure time and gain. The principle of the sequencer is shown below.

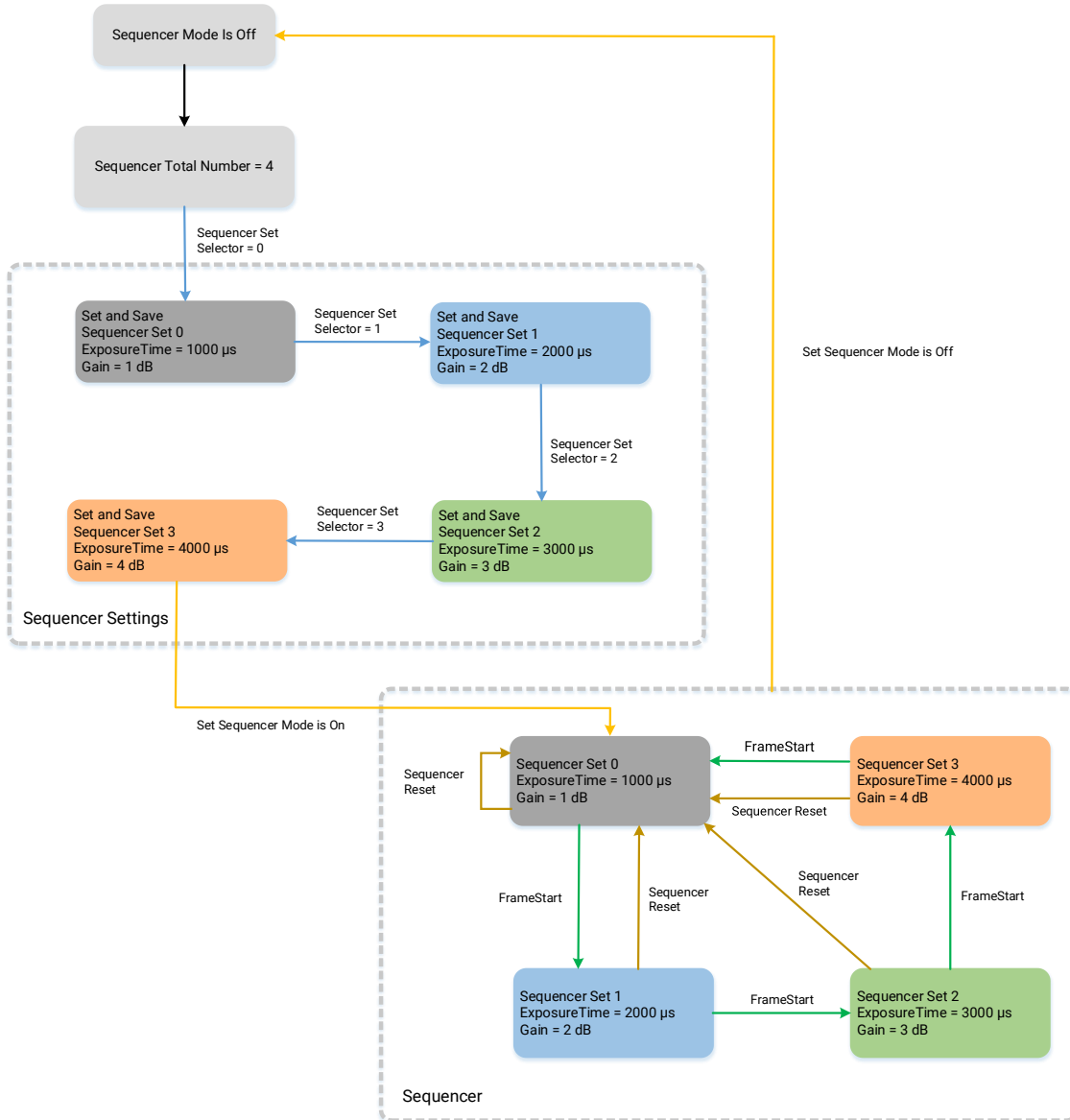
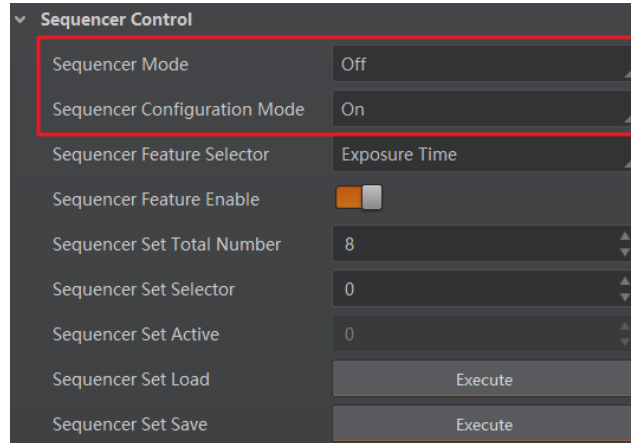


Figure 11-28 Principle of Sequencer

**Steps**

1. Go to **Sequencer Control**, select **Off** as **Sequencer Mode**, and **On** as **Sequencer Configuration Mode**.



**Figure 11-29 Set Sequencer Control**

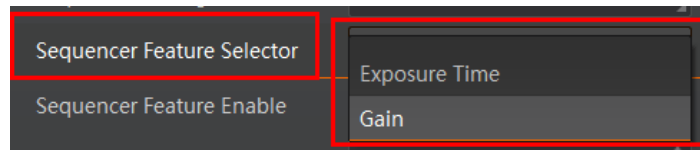
2. Set **Sequencer Set Total Number** to configure how many groups to join sequencer according to actual demands.

---

**Note**

Up to 8 groups of parameters can be configured.

3. Set **Sequencer Set Selector** to select one group of parameters, and set **Sequencer Feature Selector** to configure specific parameters.



**Figure 11-30 Sequencer Feature Selector**

---

**Note**

- You should go to the corresponding parameters to set their detailed parameters.
- **Sequencer Feature Enable** is enabled by default for configured parameters.

4. (Optional) Click **Execute** in **Sequencer Set Load** to load selected parameters in **Sequencer Set Selector**.
5. (Optional) Click **Execute** in **Sequencer Set Save** to save the selected group of parameters.
6. Repeat step 3 to step 5 to configure other group of parameters.
7. Select **On** as **Sequencer Mode** to start sequencer after configuration.

---

**Note**

You cannot configure detailed parameters of group of parameters once sequencer is started.

8. (Optional) Click **Execute** in **Sequencer Restart** to let the sequencer start from the beginning group.

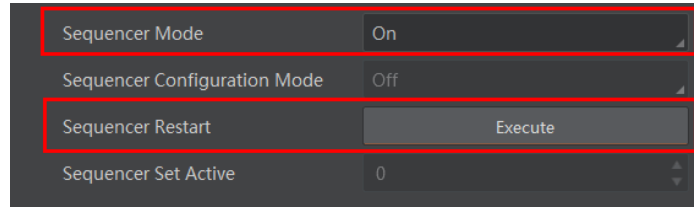


Figure 11-31 Sequencer Restart

## 11.13.2 Set HDR

### Note

- The HDR function may differ by device models.
- The device supports HDR (High Dynamic Range) function that the device acquires images based on customized settings, and each with its own exposure time and gain.

### Steps

1. Go to **Acquisition Control** → **HDR Enable**, and enable **HDR Enable**.
2. Select **0, 1,2** or **3** as **HDR Selector** according to actual demands.
3. Set corresponding **HDR Shutter** and **HDR Gain**.

### Note

Up to 4 HDR groups can be configured.

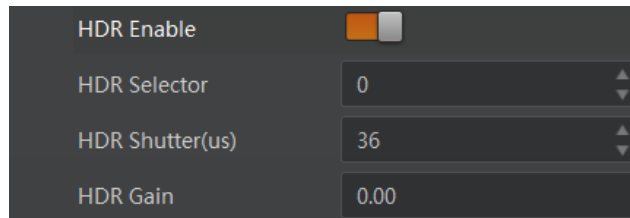


Figure 11-32 Set HDR

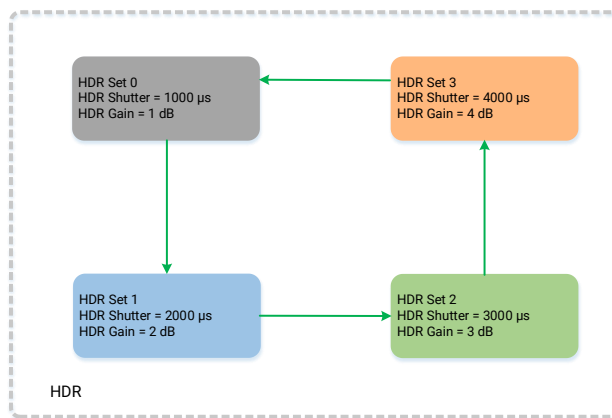


Figure 11-33 HDR Demonstration

## 11.14 Set Gain

---

### Note

The gain function may differ by device models.

---

The device has 2 types of gain, including the analog gain and digital gain. The analog gain is applied before the signal from the device sensor is converted into digital values, while digital gain is applied after the conversion.

### 11.14.1 Set Analog Gain

---

#### Note

- The analog gain parameter name may differ by device of different models or firmware. The analog gain parameter name can be **Preamp Gain** or **Gain** which have different settings method.
  - When the analog gain parameter is **Preamp Gain**, you can set it manually only.
- 

#### Preamp Gain

Go to **Analog Control** → **Preamp Gain**, and set **Preamp Gain** according to actual demands.

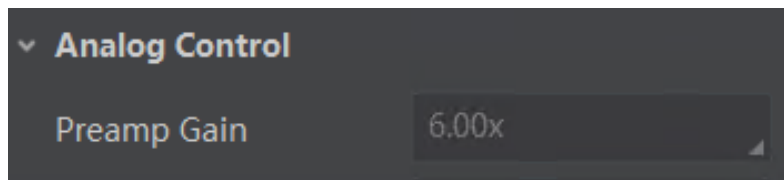


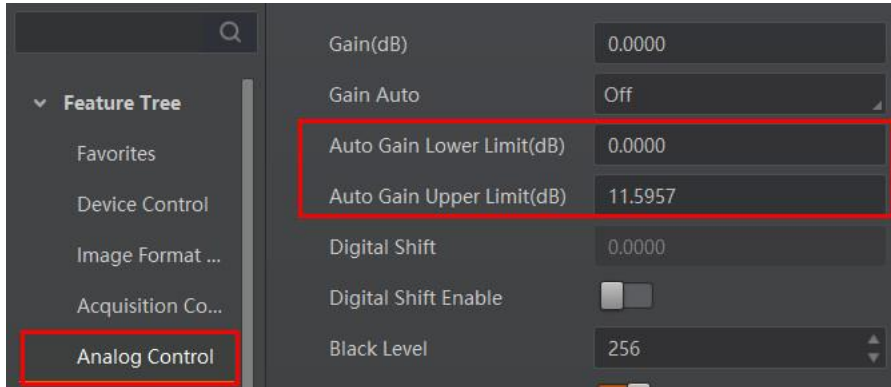
Figure 11-34 Preamp Gain

#### Gain

The device supports 3 types of gain mode, including **Off**, **Once** and **Continuous**. Click **Analog Control** → **Gain Auto**, and select **Gain Auto** according to actual demands.

- **Off**: The device **adjusts** gain according to the value configured by user in **Gain**.
- **Once**: The device adjusts the gain automatically according to the image brightness. After adjusting, it will switch to **Off** mode.
- **Continuous**: The device **adjusts** the gain continuously according to the image brightness.

When the gain mode is set as **Once** or **Continuous**, the gain should be within the range of **Auto Gain Lower Limit (dB)** and **Auto Gain Upper Limit (dB)**.



**Figure 11-35 Set Gain under Once or Continuous Mode**

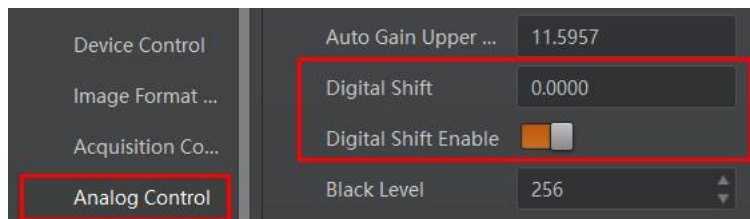
## Note

- When increasing gain, the image noise will increase too, which will influence image quality. If you want to increase image brightness, it is recommended to increase the device's exposure time first. If the exposure time reaches its upper limit, and at this point, you can increase gain.
- Some models of the device do not support **Once** or **Continuous** gain mode. You can enter **Gain (dB)** directly.

## 11.14.2 Set Digital Gain

Apart from analog gain, the device supports digital gain function. When analog gain reaching its upper limit and the image is still too dark, it is recommended to improve image brightness via digital gain.

Click **Analog Control**, enable **Digital Shift Enable**, and enter **Digital Shift** according to actual demands.



**Figure 11-36 Set Digital Gain**

## Note

When increasing the digital gain, the image noise will greatly increase too, which will severely influence image quality. It is recommended to use analog gain first, and then to adjust digital gain if the analog gain cannot meet demands.

## 11.15 User Set Customization

This function allows you to save or load device settings. The device supports four sets of parameters, including one default set and three user sets, and the relation among four sets of parameters is shown below.

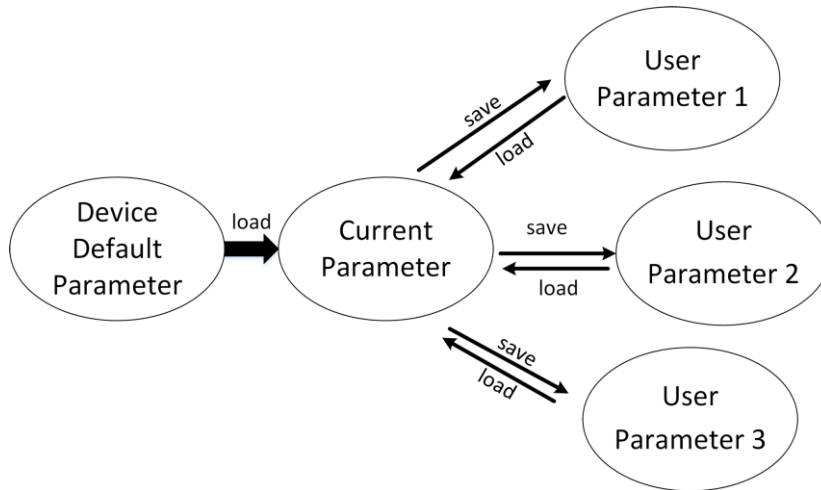


Figure 11-37 Parameter Relation

---

### Note

After setting user parameters, it is recommended to save user parameters and select them as the default parameters.

---

### 11.15.1 Save User Set

#### Steps

1. Go to **User Set Control**, and select a user set in **User Set Selector**.
- 

### Note

Here we take selecting **User Set 1** as an example.

---

2. Click **Execute** in **User Set Save** to save parameter.
3. View **User Set Save Status**:
  - Saving: User parameters are being saved.
  - Ready: User parameters have been saved.

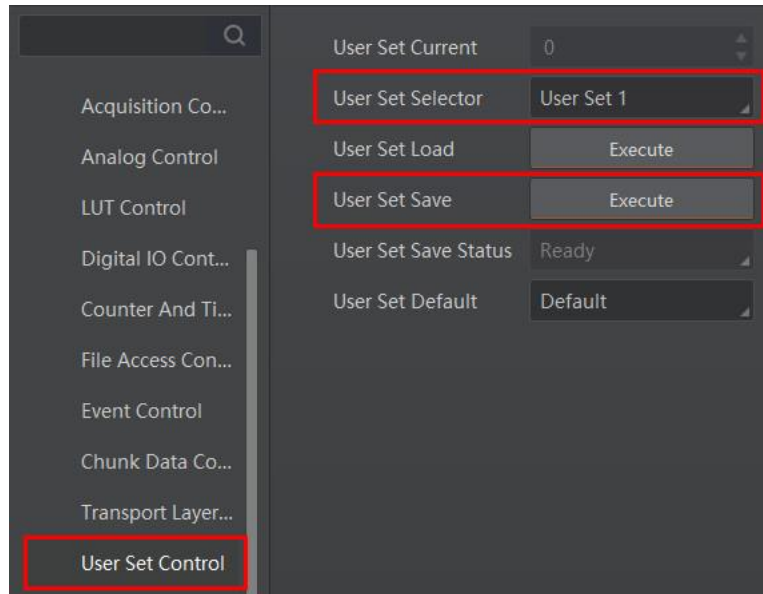


Figure 11-38 Save User Set

## 11.15.2 Load User Set

---

### Note

Loading user set is available only when the device is connected but without live view.

---

### Steps

1. Go to **User Set Control**, and select a user set in **User Set Selector**.

---

### Note

Here we take selecting **User Set 1** as an example.

---

2. Click **Execute** in **User Set Load** to load parameter.

3. View **User Set Load Status**:

- Saving: User parameters are being loaded.
  - Ready: User parameters are to be loaded.
- 

### Note

The parameter of **User Set Load Status** may differ by device models.

---



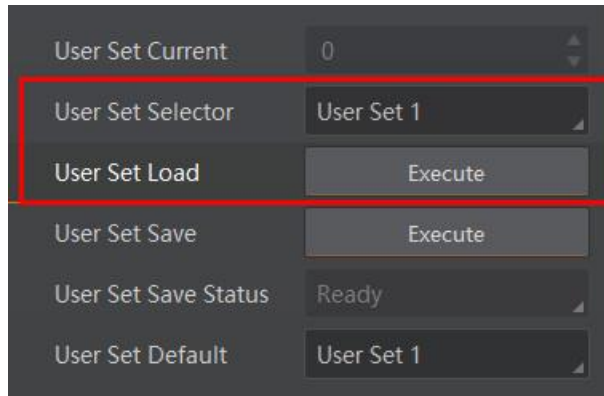


Figure 11-39 Load User Set

### 11.15.3 Set User Default

You can also set default parameter by going to **User Set Control**, and select a user set in **User Set Default**.

---

 **Note**

Here we take selecting **User Set 1** as an example.

---

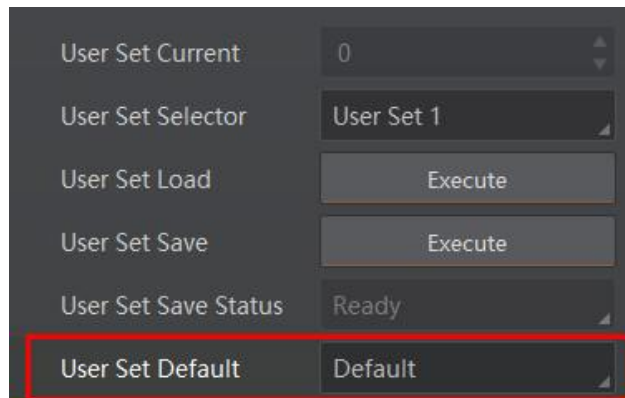


Figure 11-40 Set User Default

## Chapter 12 Advanced Functions

### 12.1 Set Black Level

---

#### Note

The black level may differ by device models.

---

The device supports black level function that allows you to change the overall brightness of an image by changing the gray values of the pixels by a specified amount.

Go to **Analog Control** → **Black Level Enable**, enable **Black Level Enable**, and enter **Black Level** according to actual demands.

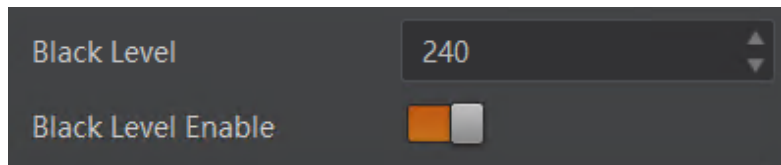


Figure 12-1 Set Black Level

### 12.2 Set Gamma Correction

---

#### Note

- The Gamma correction function may differ by device models.
  - Regarding the color device in Bayer pixel format, you need to enable **Super Bayer Enable** first before using Gamma correction function.
- 

The device supports Gamma correction function. Generally, the output of the device's sensor is linear with the photons that are illuminated on the photosensitive surface of the sensor. Gamma correction provides a non-linear mapping mechanism as shown below.

- Gamma between 0.5 and 1: image brightness increases, dark area becomes brighter.
- Gamma between 1 and 4: image brightness decreases, dark area becomes darker.

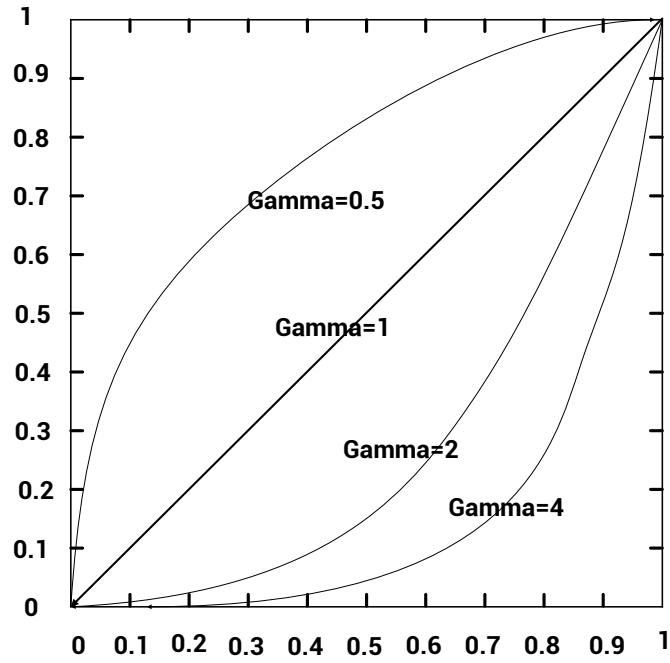


Figure 12-2 Set Gamma Correction

Table 12-1 Gamma Correction Example

Gamma Value	Image
Gamma=0.5	
Gamma=1.5	

Gamma Value	Image
Gamma=2	

There are 2 types of Gamma correction, including **User** mode and **sRGB** mode. Settings method is different as shown below.

### User Mode

#### Steps

1. Go to **Analog Control** → **Gamma Selector**.
2. Select **User** as **Gamma Selector**.
3. Enable **Gamma Enable** to enable it.
4. Enter **Gamma** according to actual demands, and its range is from 0 to 4.

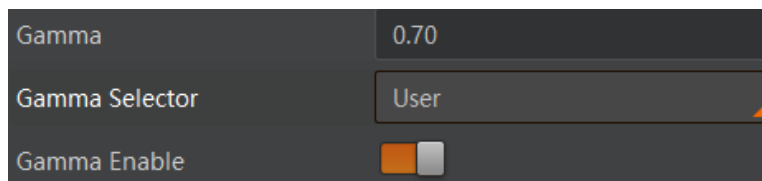


Figure 12-3 Set User Mode

### sRGB Mode

#### Steps

1. Go to **Analog Control** → **Gamma Selector**.
2. Select **sRGB** as **Gamma Selector**.
3. Enable **Gamma Enable** to enable it.

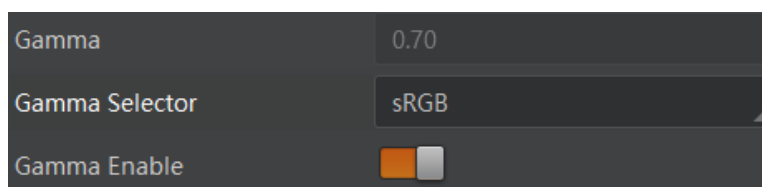


Figure 12-4 Set sRGB Mode

## 12.3 Set Digital Noise Reduction

---

### Note

- The digital noise reduction function may differ by device models.
  - Excessive noise reduction will affect the image details.
- 

The function of digital noise reduction can increase the image's SNR and improve its quality.

### Steps

1. Go to **Analog Control** → **Digital Noise Reduction Mode**.
2. Select **Expert** as **Digital Noise Reduction Mode**.
3. Enter **Denoise Strength** and **Noise Correct** according to actual demands.
  - **Denoise Strength** refers to the intensity of the digital noise reduction, you can increase it to have a better effect.
  - **Noise Correct** refers to the noise horizontal correction value, and it is used to adjust the noise curve.

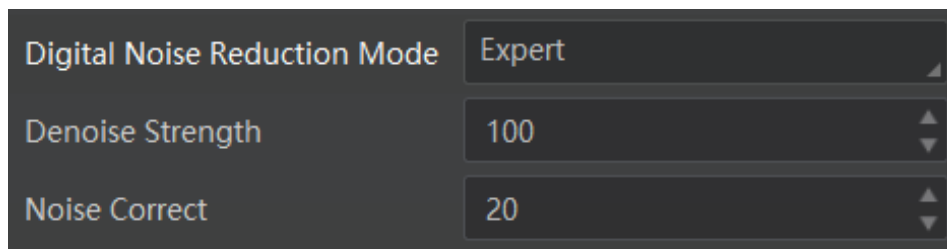


Figure 12-5 Set Digital Noise Reduction

## 12.4 Set AOI

---

### Note

- The AOI function may differ by device models.
  - AOI 1 is used when the device is in once or continuous exposure mode, and AOI 2 is used when the device is in once or continuous white balance mode.
- 

The device supports AOI function that can adjust the brightness and white balance of the entire image based on the area you selected.

### Steps

1. Click **Analog Control** → **Auto Function AOI Selector**, and select **AOI 1** or **AOI 2 Auto Function AOI Selector**.
2. Enter **Auto Function AOI Width**, **Auto Function AOI Height**, **Auto Function AOI Offset X**, and **Auto Function AOI Offset Y** according to actual demands.
3. Enable **Auto Function AOI Usage Intensity** if **AOI 1** is selected as **Auto Function AOI**

**Selector.** Or enable **Auto Function AOI Usage White Balance** if **AOI 2** is selected as **Auto Function AOI Selector**.

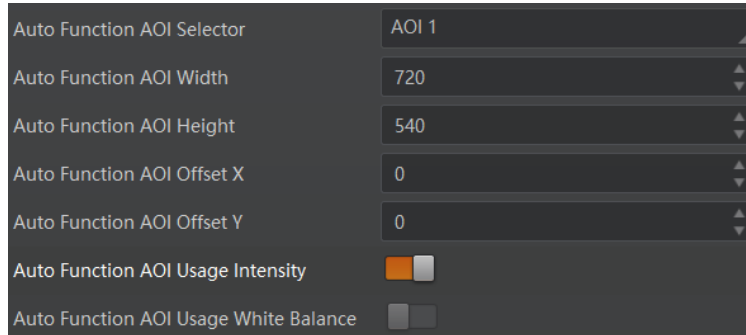


Figure 12-6 Set AOI

## 12.5 Set Color Transformation Control

---

### Note

- The function of color transformation control is only available for color devices.
  - Currently, **RGB to RGB** is available for **Color Transformation Selector** only.
- 

After the image is processed by the white balance, the overall image will be dark, and at the same time, various colors may deviate from their standard values to varying degrees. At this time, it is necessary to multiply the color of the image by the correction matrix to correct each color to its standard value, so that the overall color of the image is more vivid. The color correction function is implemented by multiplying each RGB component by a correction matrix. The currently supported color conversion module is RGB to RGB.

Two methods are available to set color transformation control.

- Method 1:

### Steps

1. Go to **Color Transformation Control**, and enable **CCM Enable**.
2. Select **Color Transformation Value Selector**, and set **Color Transformation Value** according to actual demand.

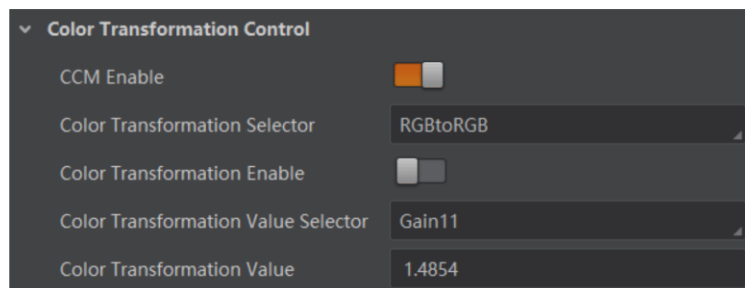


Figure 12-7 Method 1

## Note

- **CCM Enable** is used to enable color correction function. If the device you purchased does not have **CCM Enable**, then the color correction function is enabled by default.
  - Color correction is achieved by adjusting the values of the parameters in **Color Transformation Value Selector**, where Gain00, Gain10, and Gain20 adjust the R component of the red pixel, Gain01, Gain11, and Gain21 adjust the G component of the green pixel, and Gain02, Gain12, and Gain22 adjust the B component of the blue pixel.
- 
- Method 2: Go to **Color Transformation Control**, enable **Color Transformation Enable**, set **Hue** and **Saturation** to adjust **Color Transformation Value**.

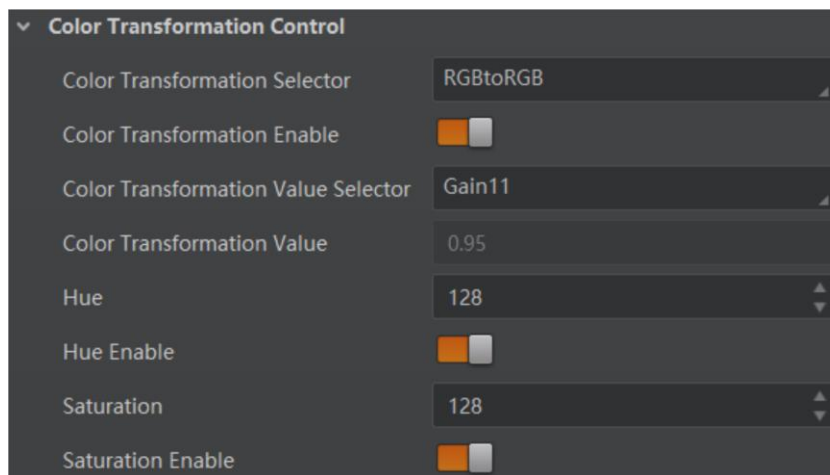


Figure 12-8 Method 2

## 12.6 Set Hue

### Note

- The hue function is only available for color devices.
- In Mono pixel format, hue function is not supported.
- The range of hue is between 0 and 255.

Adjusting the hue shifts the colors of the image. After hue is set, the device will perform color correction based on the hue value to bring the image tone to the target value. For example, when hue is set to 128, the red in the image appears as real red. When hue is 0, the hue is reversed 128 degrees counterclockwise, and red becomes blue. When hue is 255, the hue rotates 128 degrees clockwise, and red becomes green. Image examples of different hue values are shown below.

Table 12-2 Hue Example

Hue Value	Image
Hue=0	
Hue=128	
Hue=255	

**Steps**

1. Go to **Color Transformation Control**.
2. Enable **Color Transformation Enable**, and enable **Hue Enable**.
3. Enter **Hue** according to actual demands.

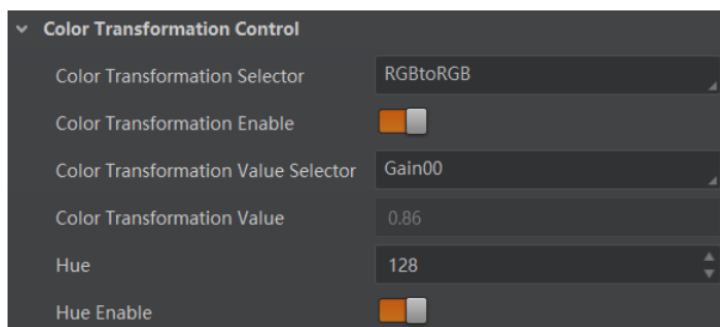


Figure 12-9 Set Hue



## 12.7 Set Saturation

**Note**

- The saturation function is only available for color devices.
- In Mono pixel format, hue function is not supported.
- The range of saturation is between 0 and 255.

Adjusting the saturation changes the colorfulness of the colors. A higher saturation, for example, makes colors easier to distinguish. Image examples of different saturation values are shown below.

**Table 12-3 Saturation Example**

Saturation Value	Image
Saturation=0	
Saturation =128	
Saturation =255	

## Steps

1. Go to **Color Transformation Control**.
2. Enable **Color Transformation Enable**, and enable **Saturation Enable**.
3. Enter **Saturation** according to actual demands.

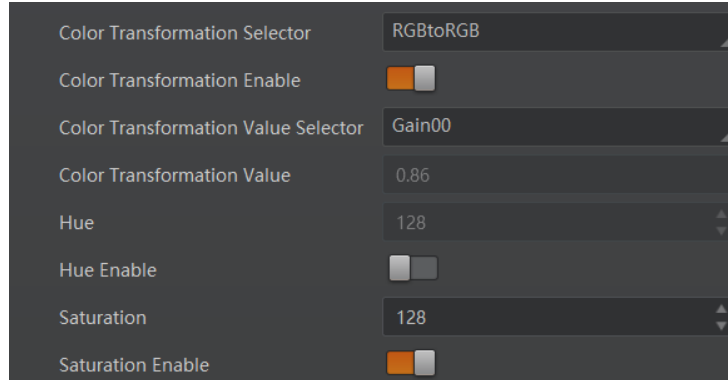


Figure 12-10 Set Saturation

## 12.8 Set Super Palette Control

---

### Note

- The function of super palette control may differ by device models.
- Regarding the color device in Bayer pixel format, you need to enable **Super Bayer Enable** first before using super palette control function.

The super palette control function allows you to select different color areas in the image to set customized hue and saturation values.

## Steps

1. Go to **Super Palette Control**, and enable **Super Palette Enable**.
2. Select **Super Palette Selector**.

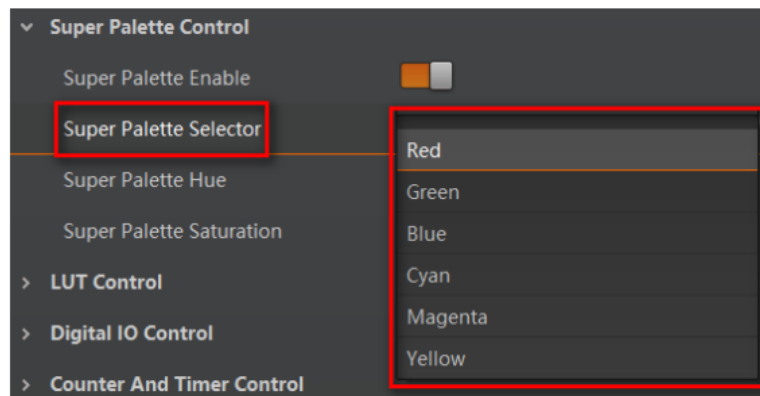


Figure 12-11 Super Palette Selector

3. Set corresponding **Super Palette Hue** and **Super Palette Saturation** according to actual demands.

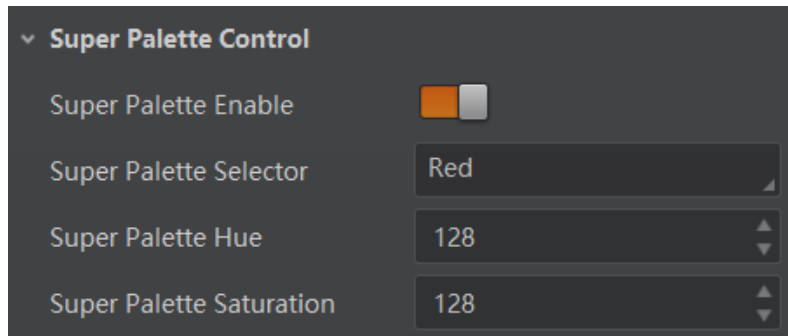


Figure 12-12 Set Super Palette Control

## 12.9 Set Sensor Mode

---

### Note

The sensor mode function may differ by device models.

---

The device provides two types of sensor mode, including high full well capacity and high sensitivity.

- High Full Well Mode: It greatly improves the overall brightness of images and is applicable to low-light environment.
- High Sensitivity: It improves the image's sensitivity.

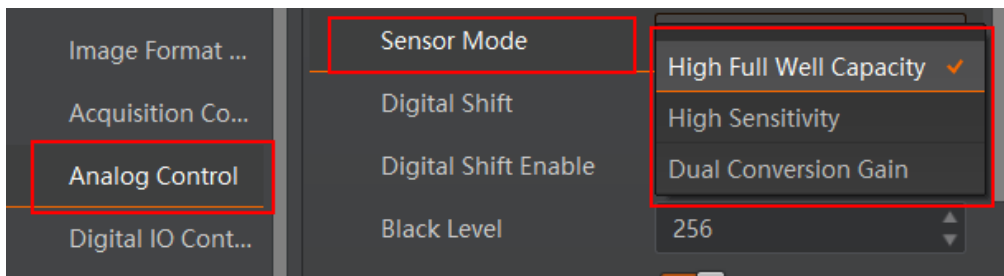


Figure 12-13 Set Sensor Mode

## 12.10 Set WDR Mode

---

### Note

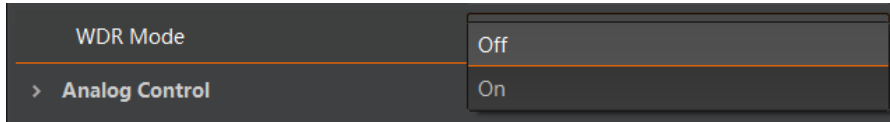
The WDR function may differ by device models.

---

The WDR function makes the device have a stable imaging ability in a changing environment between brightness and darkness.

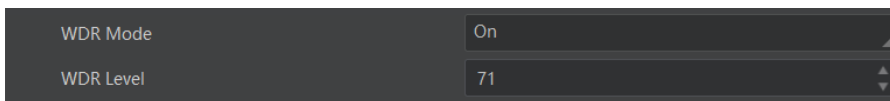
### Steps

1. Go to **Acquisition Control** → **WDR Mode**.
2. Select **On** as **WDR Mode** to enable the function or **Off** to disable it.



**Figure 12-14 Set WDR Mode**

3. Set **WDR Level** according to actual demands if the **WDR Mode** is **On**.



**Figure 12-15 Set WDR Level**

---

### Note

The range of WDR level is between 0 to 100. The larger the value, and the larger the wide dynamic range. It is recommended to set it as 71.

---

## 12.11 Set Shading Correction

---

### Note

The specific shading correction types that devices support and configuration methods may differ by device models.

---

The device supports shading correction function that improves the image uniformity when you acquire a non-uniformity image due to external conditions. The supported shading correction type includes LSC correction, FPNC correction, and PRNUC correction.

### 12.11.1 LSC Correction

LSC correction stands for Lens Shading Correction that eliminates non-uniform illumination brought by lens. The images before LSC correction and after correction are shown below.



Figure 12-16 Before LSC Correction

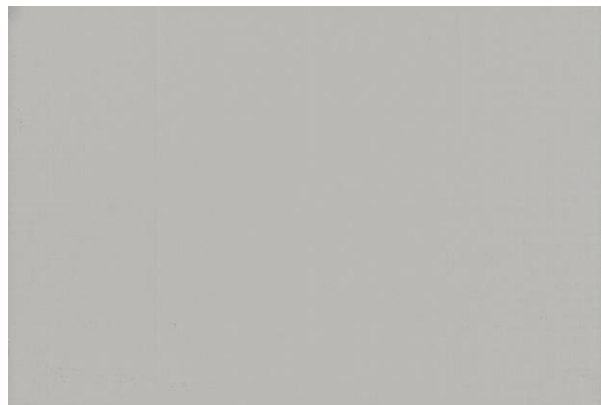


Figure 12-17 After LSC Correction

**Steps**

1. Go to **Shading Correction**, and select **LSC Correction** as **Shading Selector**.
2. Click **Execute** in **Activate Shading** to let the client software automatically calculate.
3. Enable **LSC Enable**.

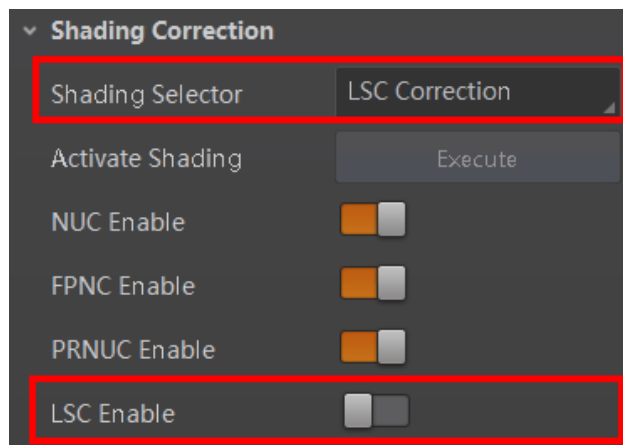


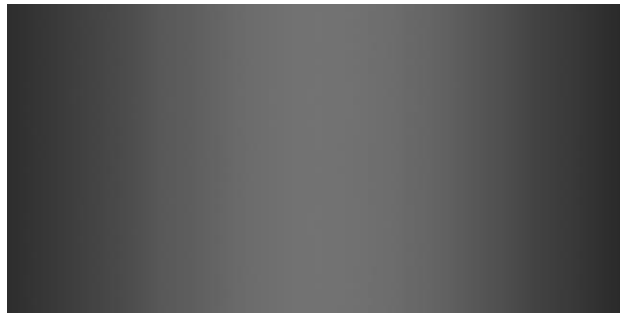
Figure 12-18 LSC Correction

 **Note**

- LSC correction should be executed in full resolution. If you are only interested in a certain region of the image, you can set a Region of Interest (ROI) instead.
  - Specific steps for executing LSC correction may differ by device models
- 

### 12.11.2 Other Corrections

Other corrections include FPNC correction and PRNUC correction. The images before correction and after correction are shown below.

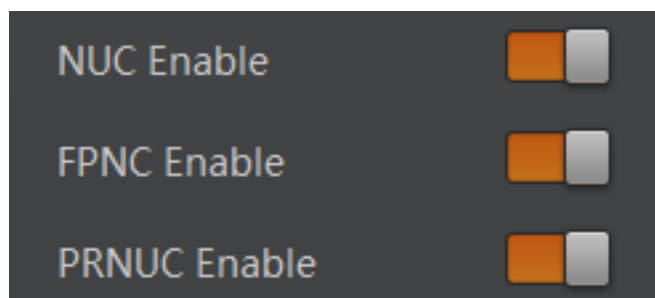


**Figure 12-19 Before Correction**



**Figure 12-20 After Correction**

Go to **Shading Correction**, and enable **NUC Enable**. The **FPNC Enable** and **PRNUC Enable** will be automatically enabled or disabled according to the device's condition.



**Figure 12-21 Other Corrections**

## 12.12 Set Channel Correct Mode

### Note

The channel correct mode function may differ by device models.

The channel correction function allows you to adjust the image's uniformity, and you can set channel correct mode as shown below.

Go to **Analog Control** → **Channel Correct Mode**, and select **Channel Correct Mode** according to actual demands.

- **Active Mode** adjusts channel difference in accordance with actual images in real time.
- **Noise Correct** adjusts channel difference in accordance with configured parameters in real time.

Channel Correct Mode	Active Mode
Fan Open Threshold	Active Mode
Auto Function AOI Selector	Passive Mode

Figure 12-22 Set Channel Correct Mode

## 12.13 Set LUT

A Look-Up Table (LUT) is a customizable grayscale-mapping table. You can stretch, amplify the grayscale range that interests you. The mapping can be linear or customized curve.

### Note

- You cannot use Gamma correction function and LUT function at the same time.
- The parameter of **LUT Save** may differ by device models. If the device has no **LUT Save**, the settings you configured will be saved in the device in real time.
- For different models of device, the **LUT Index** and **LUT Value** range may differ, please refer to the actual one you got.
- Regarding the color device in Bayer pixel format, you need to enable **Super Bayer Enable** first before using LUT function.

## Steps

1. Click **LUT Control**, and enable **LUT Enable**.
2. Enter **LUT Index** and **LUT Value** according to actual demands.
3. Click **Execute** in **LUT Save** to save it.

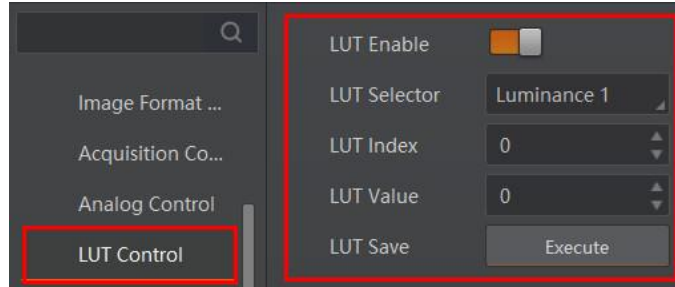


Figure 12-23 Set LUT

## 12.14 Event Control

---

### Note

The event control function may differ by device model.

---

The event control can record events happen to the device and allow you to view them.

### Steps

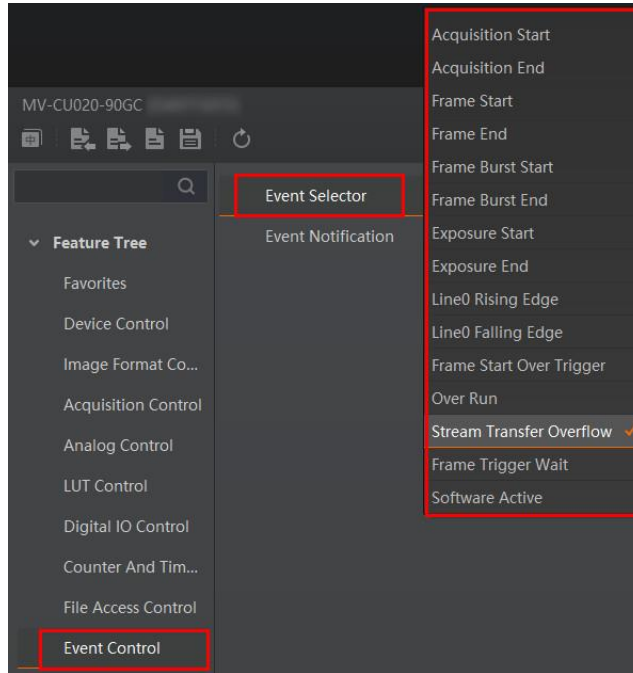
1. Go to **Event Control** → **Event Selector**, and select **Event Selector** according to actual demands.
- 

### Note

The specific events may differ by device models.

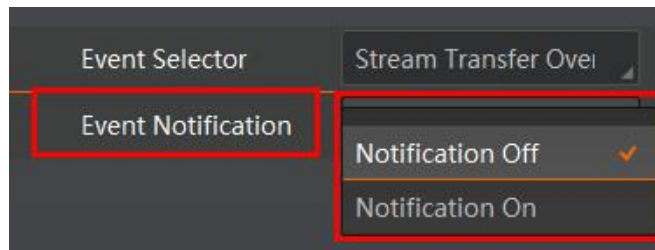
---





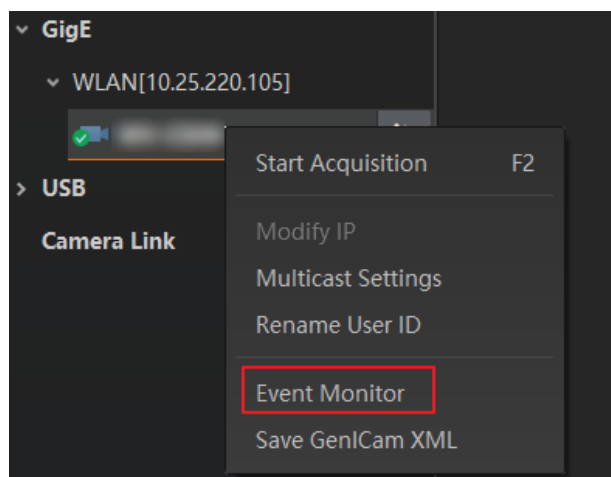
**Figure 12-24 Event Selector**

2. Select **Notification On** as **Event Notification** to output event.



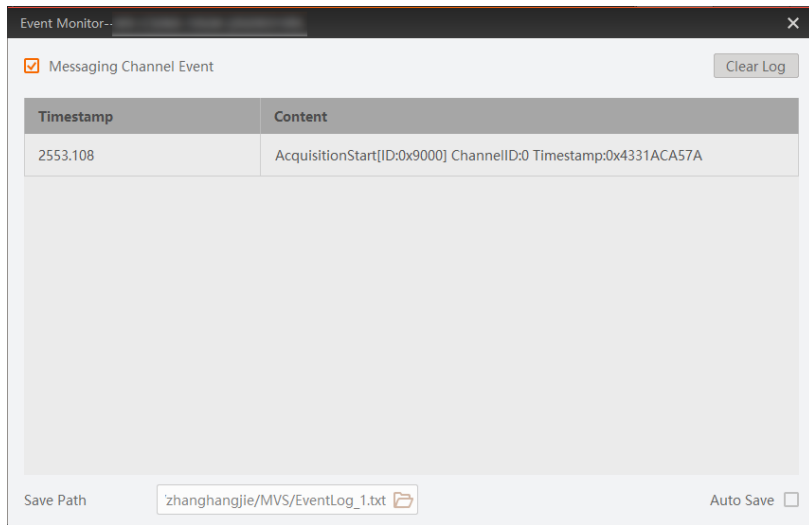
**Figure 12-25 Set Event Control**

3. Right click the connected device and click **Event Monitor**.



**Figure 12-26 Event Monitor**

4. Check **Messaging Channel Event**, and view specific event after device starts live view.



**Figure 12-27 Event Monitor Window**

## 12.15 Transfer Control

You can go to **Transfer Control** to view the device's transfer sources, transfer mode, queue information, etc.

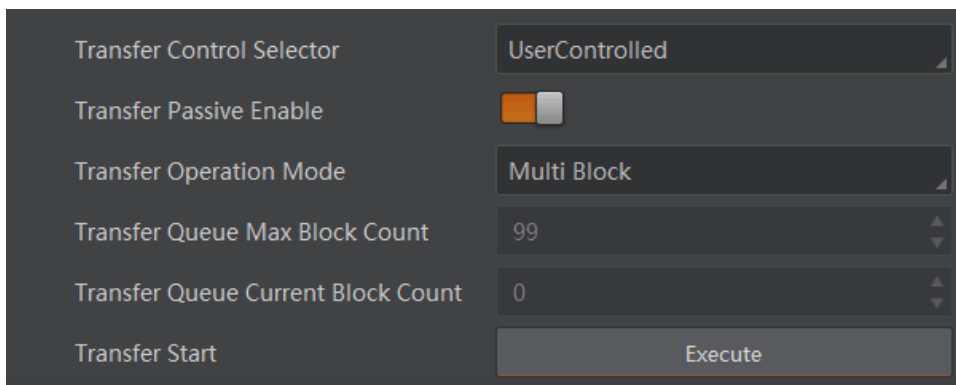
### Note

The specific parameters of transfer control may differ by device models.

---

### 12.15.1 User Controlled Transfer Control

The parameters of user controlled transfer control are shown below.



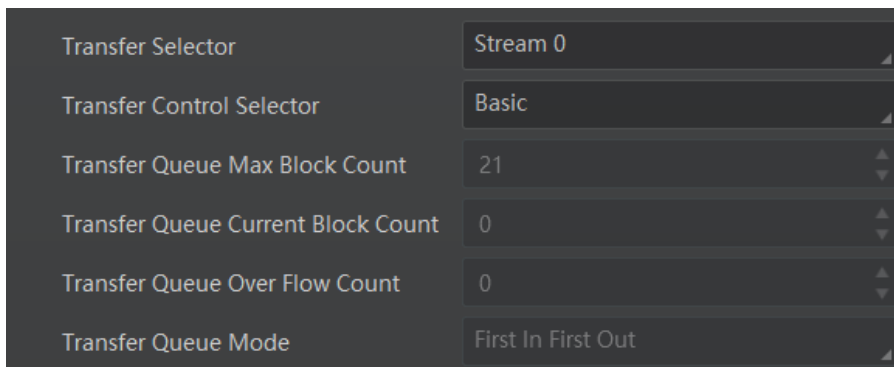
**Figure 12-28 User Controlled Transfer Control**

**Table 12-4 Parameters of User Controlled Transfer Control**

Parameter	Read/Write	Description
Transfer Control Selector	Read & Write	It selects the transfer mode. <ul style="list-style-type: none"> <li>● Basic: In this mode, the device sends images to the client software directly after acquiring images.</li> <li>● User Controlled: In this mode, the device saves images in its internal cache first, and then sends to the client software after acquiring images.</li> </ul>
Transfer Passive Enable	Read & Write	The transfer passive node will be displayed if it is enabled. <b>Note</b> You should select <b>User Controlled</b> as <b>Transfer Control Selector</b> first.
Transfer Operation Mode	Read & Write	It is the transfer operation mode: <ul style="list-style-type: none"> <li>● Single Block: Click <b>Execute</b> in <b>Transfer Strat</b> to let the device transfer one image each time.</li> <li>● Multi Block: Click <b>Execute</b> in <b>Transfer Strat</b> to let the device transfer multiple images in cache.</li> </ul>
Transfer Queue Max Block Count	Read Only	It displays the max. image quantity that the device's memory can save before the compression.
Transfer Queue Current Block Count	Read Only	It displays current image quantity saved by the memory.
Transfer Start	Read & Write	Click <b>Execute</b> to let the device transfer images.

### 12.15.2 Basic Transfer Control

The parameters of basic transfer control are shown below.



**Figure 12-29 Basic Transfer Control**

**Table 12-5 Parameters of Basic Transfer Control**

Parameter	Read/Write	Description
Transfer Selector	Read & Write	It selects the transfer source.
Transfer Control Selector	Read & Write	It selects the transfer mode.
Transfer Queue Max Block Count	Read Only	It displays the max. image quantity that the device's memory can save before the compression.
Transfer Queue Current Block Count	Read Only	It displays current image quantity saved by the memory.
Transfer Queue Over Flow Count	Read & Write	It is the image quantity discarded by FPGA.
Transfer Queue Mode	Read & Write	It is the operating mode of memory queue.

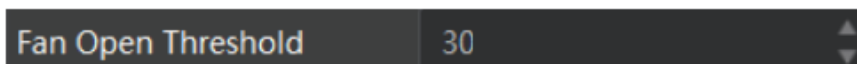
## 12.16 Set Cooling Fan

### Note

- The cooling fan may differ by device models.
- The temperature unit here is Celsius degree.

For device with cooling fan, you can go to **Analog Control** → **Fan Open Threshold** to set fan parameters.

When the device's temperature is higher than the value you set in **Fan Open Threshold**, the fan starts to work. Otherwise, the fan stops working.



**Figure 12-30 Set Cooling Fan**

## Chapter 13 Other Functions

### 13.1 Device Control

#### Note

The specific device control parameters may differ by device models.

In **Device Control**, you can view device information, edit device name, reset device, etc. The specific parameters in **Device Control** are shown below.

**Table 13-1 Parameter Description**

Parameter	Read/Write	Description
Device Type	Read Only	It is the device type.
Device Scan Type	Read Only	It is the scan type of the device's sensor.
Device Vendor Name	Read Only	It is the name of the manufacturer of the device.
Device Model Name	Read Only	It is the model of the device.
Device Manufacturer Info.	Read Only	It is the manufacturer information about the device.
Device Version	Read Only	It is the version of the device.
Device Firmware Version	Read Only	It is the firmware version of the device.
Device Serial Number	Read Only	It is device's serial number.
Device ID	Read Only	It is the device's ID.
Device User ID	Read & Write	Device name and it is empty by default. You can set according to your preference. <ul style="list-style-type: none"> <li>• If User ID is empty, the client software displays the device model.</li> <li>• If you set it, the client software displays the User ID you set.</li> </ul>
Device Uptime (s)	Read Only	It is the period of time when device is powered up.
Board Device Type	Read Only	It is the device type.
Device Connection Selector	Read & Write	It selects which connection of the device to control.
Device Connection Speed	Read Only	It indicates the speed of transmission of the

## GigE Area Scan Camera User Manual

---

Parameter	Read/Write	Description
(Mbps)		specified connection.
Device Link Selector	Read & Write	It selects which link of the device to control
Device Link Speed (Mbps)	Read Only	It indicates the speed of transmission negotiated on the specified link.
Device Link Connection Count	Read Only	It returns the number of physical connection of the device used by a particular link.
Device Link Heartbeat Mode	Read & Write	It activates or deactivates the link's heartbeat.
Device Stream Channel Count	Read only	It indicates the number of streaming channels supported by the device.
Device Stream Channel Selector	Read & Write	It selects the stream channel to control.
Device Stream Channel Type	Read Only	It reports the type of the stream channel.
Device Stream Channel Link	Read Only	It is the index of device's link to use for streaming the specified stream channel.
Device Stream Channel Endianness	Read Only	It is the endianness of multi-byte pixel data for this stream.
Device Stream Channel Packet Size (B)	Read & Write	It specifies the stream packet size, in bytes, to send on the selected channel for a transmitter or specifies the maximum packet size supported by a receiver.
Device Event Channel Count	Read Only	It indicates the number of event channels supported by the device.
Device Character Set	Read Only	It is character set used by the strings of the device's bootstrap registers.
Device Reset	Write Only	Click <b>Execute</b> to reset the device.
Device Temperature Selector	Read & Write	It selects device component to view its temperature. Currently, only sensor can be selected only.
Device Temperature	Read Only	It displays the temperature of selected components in <b>Device Temperature Selector</b> .
Relative Humidity	Read Only	It displays the device's internal relative humidity.
Device Fan Enable	Read & Write	It enables fan function.
TEC Enable	Read & Write	It enables TEC function.

Parameter	Read/Write	Description
TEC Temperature	Read & Write	It sets the target of TEC temperature in degrees Celsius (°C).
TEC Voltage	Read Only	It is the TEC voltage.
Find Me	Read & Write	The function of finding me is executed. Click <b>Execute</b> to find the currently operating device.
Device Max Throughput (Kbps)	Read Only	It is max. bandwidth of the data that can be streamed out of the device.
Device PJ Number	Read Only	It is the device's project number.
HB Abnormal Monitor	Read Only	It monitors image stream condition.
HB Version	Read Only	It is the version of the image compression mode.

## 13.2 Transport Layer Control

You can go to **Transport Layer Control** to view the device's payload size, GenCP version, etc.

### Note

The specific parameters of transport layer control may differ by device models.

**Table 13-2 Parameters of Transport Layer Control**

Parameter	Read/Write	Description
Paylode Size	Read Only	It is the device's load size.
GenCP Version Major	Read Only	It is the major version in GenCP version.
GenCP Version Minor	Read Only	It is the minor version in GenCP version.
GEV Device Mode Is Big Endian	Read Only	It is the endianness in device's register.
GEV Device Mode Character Set	Read Only	It is the character set in device's register.
GEV Interface Selector	Read Only	It sets which physical network interface to be controlled.
GEV MAC Address	Read Only	It is the MAC address of the network interface.
GEV Supported Option Selector	Read & Write	It selects the GEV option to interrogate for existing support.
GEV Supported Option	Read Only	It indicates whether the selected GEV

## GigE Area Scan Camera User Manual

---

Parameter	Read/Write	Description
		option is supported or not.
GEV Current IP Configuration LLA	Read Only	It indicates whether the Link Local Address IP configuration scheme is activated on the given network interface.
GEV Current IP Configuration DHCP	Read & Write	It indicates whether the DHCP IP configuration scheme is activated on the given network interface.
GEV Current IP Configuration Persistent IP	Read & Write	It indicates whether persistent IP configuration scheme is activated on the given network interface.
DEV PAUSE Frame Reception	Read & Write	It controls whether incoming pause frames are handled on the given logical link.
GEV Current IP Address	Read Only	It is the current IP address for the given network interface.
GEV Current Subnet Mask	Read Only	It is the current subnet mask of the given interface.
GEV Current Default Gateway	Read Only	It is the default gateway IP address to be used on the given network interface.
GEV First URL	Read Only	It is the first choice of URL for the XML device description file.
GEV Second URL	Read Only	It is the second choice of URL to the XML device description file.
GEV Number of Interfaces	Read Only	It indicates the number of physical network interfaces supported by this device.
GEV Persistent IP Address	Read & Write	It indicates the persistent IP address for this network interface. It is only used when the device boots with the persistent IP configuration scheme.
GEV Persistent Subnet Mask	Read & Write	It indicates the persistent subnet mask associated with the persistent IP address on this network interface. It is only used when the device boots with the persistent IP configuration scheme.
GEV Persistent Default Gateway	Read & Write	It indicates the persistent default gateway for this network interface. It is only used when the device boots with the persistent



## GigE Area Scan Camera User Manual

---

Parameter	Read/Write	Description
		IP configuration scheme.
GEV Link Speed	Read Only	It indicates the speed of transmission negotiated by the given network interface in Mbps.
GEV Message Channel Count	Read Only	It indicates the number of message channels supported by this device.
GEV Stream Channel Count	Read Only	It indicates the number of stream channels supported by this device.
GEV Heartbeat Timeout (ms)	Read & Write	It indicates the current heartbeat timeout in milliseconds.
GEV Heartbeat Disable	Read & Write	It disables the GEV Heartbeat.
GEV Timestamp Tick Frequency (Hz)	Read Only	It indicates the number of timestamp ticks in 1 second (frequency in Hz).
Timestamp Control Latch	Read & Write	It latches the current timestamp value of the device.
Timestamp Control Reset	Read & Write	It resets the timestamp value for the device.
Timestamp Control Latch Reset	Read & Write	It resets the timestamp control latch.
Timestamp Value	Read Only	It is a read only element. It indicates the latched value of the timestamp.
GEV CCP	Read & Write	It controls the device access privilege of an application.
GEV Stream Channel Selector	Read Only	It selects the stream channel to control.
GEV SCP Interface Index	Read Only	It is the Index of network interface to be used.
GEV SCP Host Port	Read & Write	It is the host port of the channel
GEV SCP Direction	Read Only	It transmits or receives the channel.
GEV SCPS Fire Test Packet	Read Only	It sends a test packet.
GEV SCPS Do Not Fragment	Read & Write	The state of this feature is copied into the "do not fragment" bit of the IP header of each stream packet.
GEV SCPS Big Endian	Read Only	It is the Endianness of multi-byte pixel data for this stream.

## GigE Area Scan Camera User Manual

---

Parameter	Read/Write	Description
GEV SCPS Packet Size(B)	Read & Write	It specifies the stream packet size (in bytes) to send on this channel.
GEV SCPD	Read & Write	It indicates the delay (in timestamp counter units) to insert between each packet for this stream channel.
GEV SCDA	Read & Write	It indicates the destination IP address for this stream channel.
GEV SCSP	Read Only	It indicates the source UDP port address for this stream channel.
GEV MCP Host Port	Read & Write	It controls the port to which the device must send messages. Setting this value to 0 closes the message channel.
GEV MCDA	Read & Write	It controls the destination IP address for the message channel.
GEV MCTT (ms)	Read & Write	It provides the transmission timeout value in milliseconds.
GEV MCRC	Read & Write	It controls the number of retransmissions allowed when a message channel message times out.
GEV MCSP	Read Only	It indicates the source port for the message channel.
Gev IEEE 1588	Read & Write	It enables the IEEE 1588 Precision Time Protocol to control the timestamp register.
Gev IEEE 1588 Status	Read Only	The status of the IEEE 1588 Precision Time Protocol.
Gev GVSP Extended ID Mode	Read & Write	It enables the extended ID mode.

## 13.3 Embed Information into Image

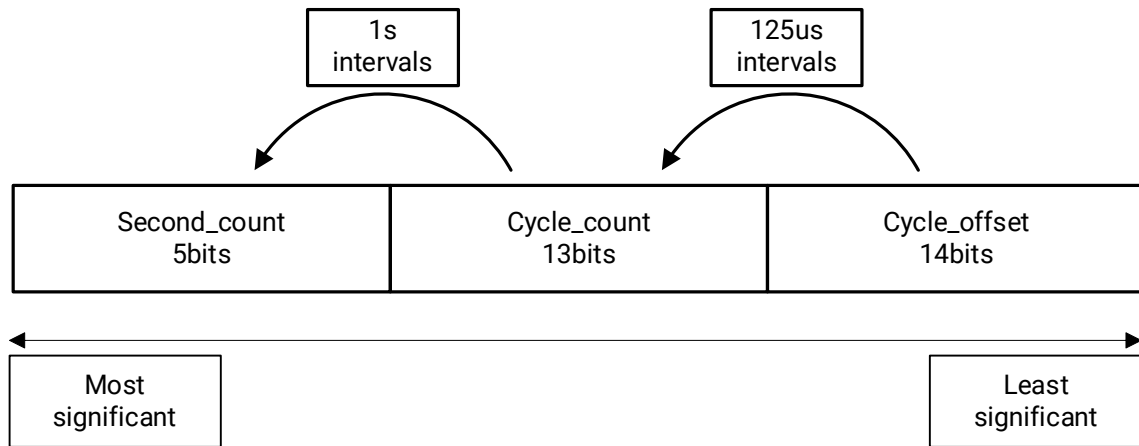
The device supports embedding information into image data. The information will be embedded into the image according to the enabling condition of each type of information in the order of the image embedding information listed in the table below.

### Note

- **White Balance** is only available for the color devices.
- **Width, Height, Offset X, Offset Y** and **Pixel Format** are image embedding information that the device supporting Chunk function has.

**Table 13-3 Image Embedding Information**

Image Embedding Info.	Byte	Data Format
Timestamp	4	Refer to figure 11-1
Gain	4	4 bytes are used to transfer the gain information. Each low 8 bits of the 4 valid data are combined to transfer the gain information. Value Range: 0 to 1023. Note: High bits will be complemented with 0 automatically.
Exposure	4	4 bytes are combined to show the exposure time, and the unit is $\mu\text{s}$ .
Brightness Info	4	Ranges from 0 to 4095
White Balance	8	R/G/B occupies 2 bytes each. Value Range: 0 to 4095.
Frame Counter	4	Ranges from 0 to $2^{32}-1$
Ext Trigger Count	4	Ranges from 0 to $2^{32}-1$
Line Input Output	4	The 1 <sup>st</sup> byte is input, and each bit corresponds to 1 input. The 2 <sup>nd</sup> byte is output, 3 <sup>rd</sup> and 4 <sup>th</sup> bytes are reserved.
Width	4	Ranges from 0 to $2^{32}-1$
Height	4	Ranges from 0 to $2^{32}-1$
Offset X	4	Ranges from 0 to $2^{32}-1$
Offset Y	4	Ranges from 0 to $2^{32}-1$
Pixel Format	4	Ranges from 0 to $2^{32}-1$
ROI Position	8	The starting coordinates occupy two bytes each with the column coordinates at the front and the row coordinates at the back. The length and width coordinates each occupy two bytes.



**Figure 13-1 Data Format of Timestamp**

There are two ways to embed information into the image, including watermark function and Chunk function.

---

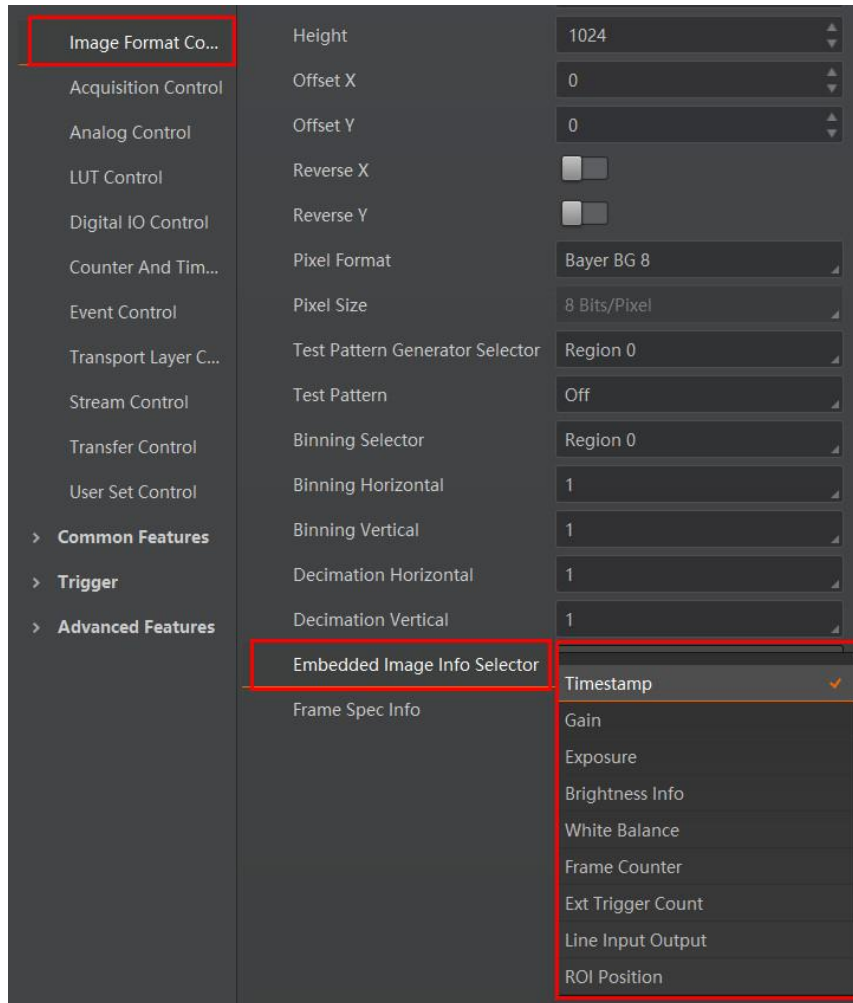
**Note**

- Watermark function is not available if the device enables image compression mode.
  - The Chunk function may differ by device models.
  - The device uses Chunk function in priority if it supports both watermark and Chunk function.
- 

### 13.3.1 Watermark Settings

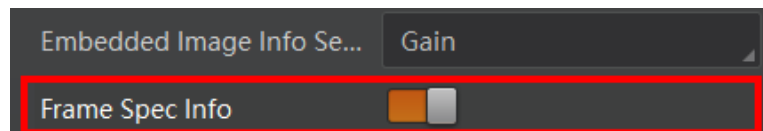
**Steps**

1. Go to **Image Format Control** → **Embedded Image Info Selector**, and select **Embedded Image Info Selector** according to actual demands.




**Figure 13-2 Select Embedded Image Info Selector**

2. Enable **Frame Spec Info** to add watermark into images.



**Figure 13-3 Enable Frame Spec Info**

3. (Optional) Repeat steps above to add multiple watermarks.

4. Click  on the control toolbar of the client software to view specific watermark information.

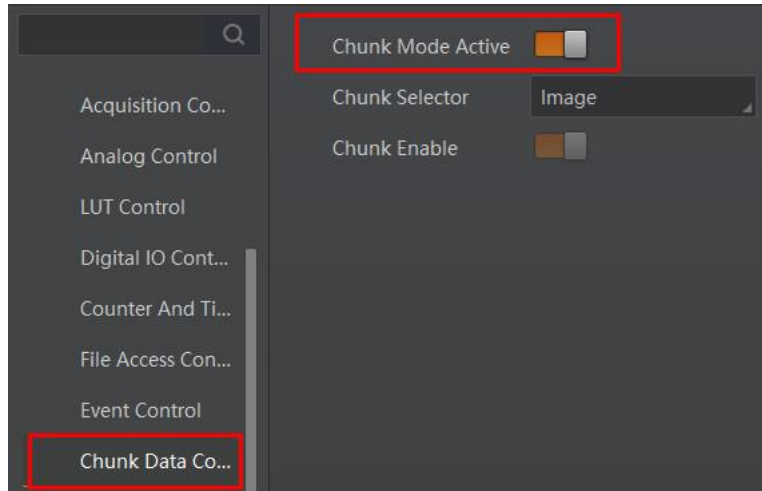
## Note

The watermark is embedded into the starting position of the first line of image data. If the ROI is small and the first line of image data is insufficient to embed information, the information will be embedded into the second line of image data.

### 13.3.2 Chunk Settings

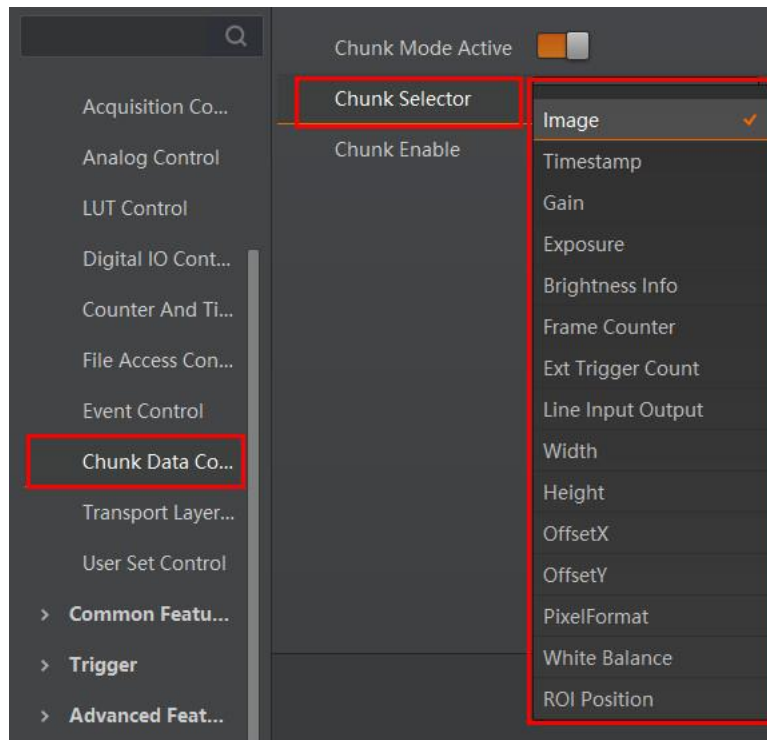
**Steps**

1. Go to **Chunk Data Control** → **Chunk Mode Active**, and **Chunk Mode Active**.



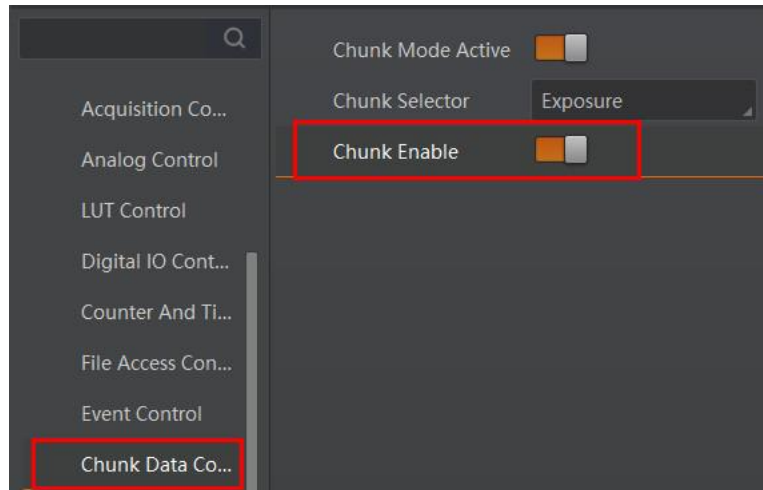
**Figure 13-4 Enable Chunk Mode Active**

2. Select **Chunk Selector** according to actual demands.




**Figure 13-5 Select Chunk Selector**

3. Enable **Chunk Enable** to embed information into the image.



**Figure 13-6 Chunk Enable**

4. (Optional) Repeat steps above to add multiple Chunk information types.
5. Click  on the control toolbar of the client software to view specific information.

## 13.4 Set Action Command

---

### Note

- The action command function may differ by device models.
  - Only V3.1.0 and above version of MVS client software support GigE Vision action command.
- 

The action command allows you to execute actions on multiple devices at roughly the same time by using a single broadcast protocol message.

### Steps

1. Go to **Transport Layer Control** → **GEV IEEE 1588**, and enable **GEV IEEE 1588**.
2. Go to **Acquisition Control** → **Trigger Selector**, and select **Frame Burst Start**.
3. Select **On** as **Trigger Mode**.
4. Select **Action 1** as **Trigger Source**.
5. Go to **Tool** → **GigE Vision Action Command** in the menu bar.

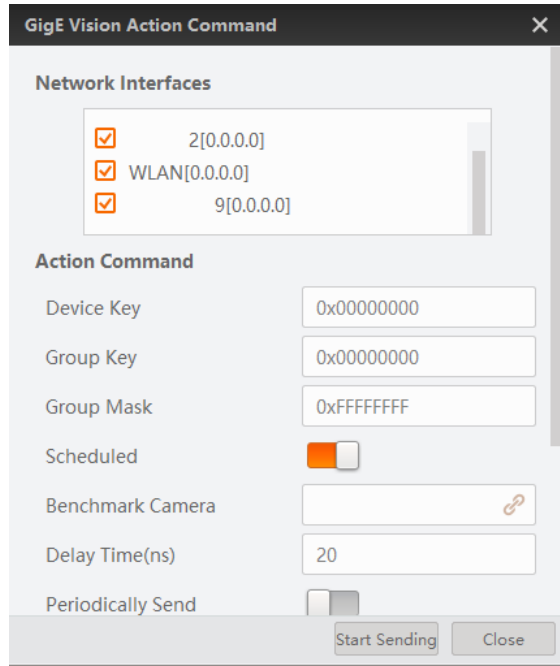



Figure 13-7 GigE Vision Action Command

6. Select **Network Interfaces** to set the subnet that the command to be sent to.
7. Enter **Device Key**, **Group Key**, and **Group Mask**.

Table 13-4 Parameter Description

MVS Parameter Name	Device Parameter Name	Description
Device Key	Action Control → Action Device Key	The parameter value should be the same.
Group Key	Action Control → Action Group Key	The parameter value should be the same.
Group Mask	Action Control → Action Group Mask	The bitwise AND operation of the <b>Group Mask</b> against the <b>Action Group Mask</b> feature should results in non-zero.

8. Enable **Scheduled**.
9. Click  in **Benchmark Camera** to select one device as benchmark device. Once benchmark device is selected, other devices keep time synchronization with it.
10. (Optional) Enter **Delay Time** according to actual demands.

 **Note**

- The delay time should NOT be shorter than the maximum time required to transmit the command across the network.



- When the benchmark device receives the command, all devices will trigger certain actions simultaneously after the specified delay time.

11. (Optional) Enable **Periodically Send** to enable the client to send commands periodically, and enter **Sending Interval** according to actual demands.

### Note

The default value of sending interval is 1000 ms, and its range is from 1 ms to 3600000 ms.

12. (Optional) Enable **Request Acknowledgement** to display the acknowledgement messages.

13. Click **Start Sending**.

## 13.5 File Access Control

### Note

The file access control function may differ by device model.

The file access function can import or export the device's feature files and save them in mfa format. The supported feature files include **User Set 1/2/3**, **DPC**, **LUT Luminance 1/2/3**, and **License Notice**.

### Steps

1. Select a device in the device list, and click  to open the file access dialogue box.

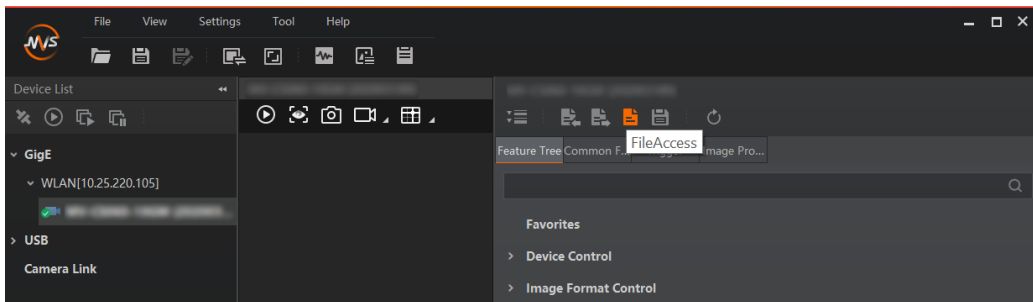


Figure 13-8 File Access

2. Select **Device Feature** and click **Import** or **Export**.

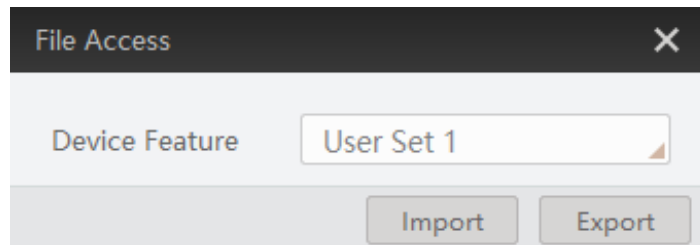


Figure 13-9 Import or Export

3. Select a mfa file from local PC to import or select a saving path and enter file name to save and export.

---

## Note


- If **User Set 1/2/3** is selected as device feature, you need to load the corresponding user set you selected to take effect.
  - If **LUT Luminance 1/2/3** is selected as device feature, and they will take effect only when you select the same parameters in LUT Selector.
  - If **DPC** is selected as device feature, and it will take effect immediately.
  - **License Notice** supports exporting only.
  - Importing and exporting the device feature among the same model of devices are supported.
- 

## 13.6 Multicast Function

The multicast function enables multiple PCs to access the same device at the same time. At the same time, the same device can only be connected by one client in controller and data receiver mode or controller mode, but can be connected by multiple clients in data receiver mode. The multicast mode of each device within the client is controlled individually. The description of three multicast modes is shown below.

**Table 13-5 Multicast Mode Description**

Multicast Mode	Description
Controller and Data Receiver	This mode allows you to read and edit the device's parameters, and get its image data.
Controller	This mode allows you to read and edit the device's parameters, but you cannot get its image data.
Data Receiver	This mode allows you read the device's parameters and get its image data, but you cannot edit its parameters.

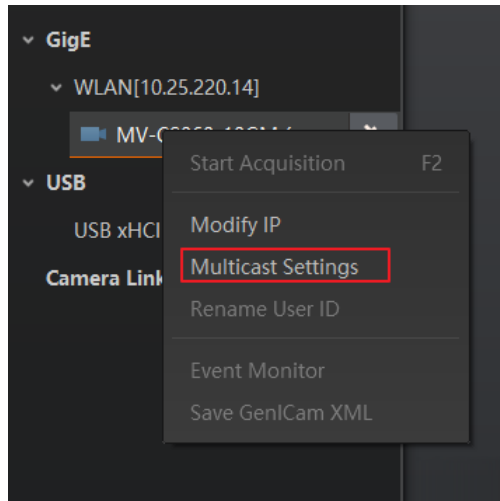
When the multicast function is enabled, the device icon on the client software of other PCs will become , and you can connect the device via the data receiver mode. You can set multicast function for both the available device and connected device in the device list, but the specific settings are different.

### 13.6.1 Set Multicast (Available Status)

Follow steps below to set multicast function if the device is in available status.

#### Steps

1. Right click the available device, and click **Multicast Settings**.

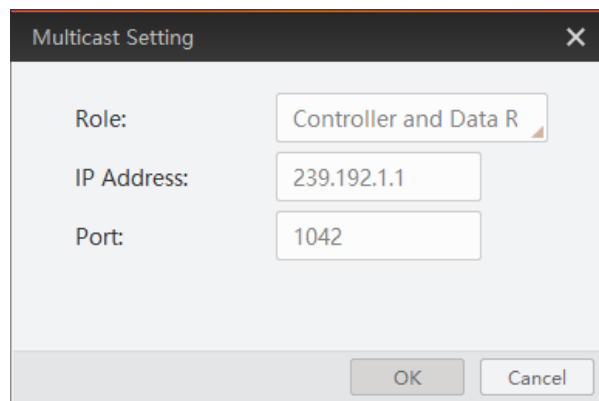


**Figure 13-10 Multicast Settings**

2. Select **Role**, and enter the **IP Address** and **Port**.

### **Note**

- The available status device can use multicast function in Controller and Data Receiver mode or Controller mode.
- The IP address should be class D IP address, and the port ranges from 0 to 65535.



**Figure 13-11 Set Parameters**

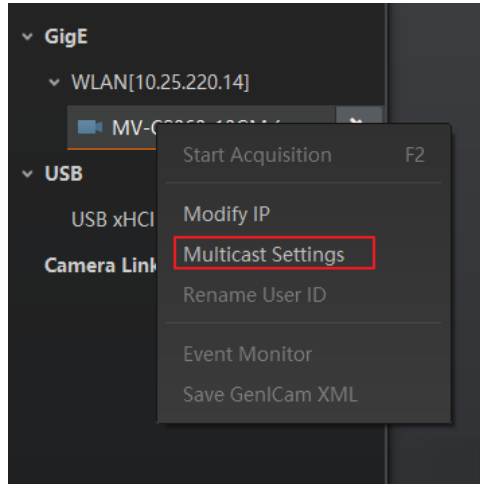
3. Click **OK**.

## 13.6.2 Set Multicast (Connected Status)

Follow steps below to set multicast function if the device is in connected status.

### **Steps**

1. Right click the available device, and click **Multicast Settings**.



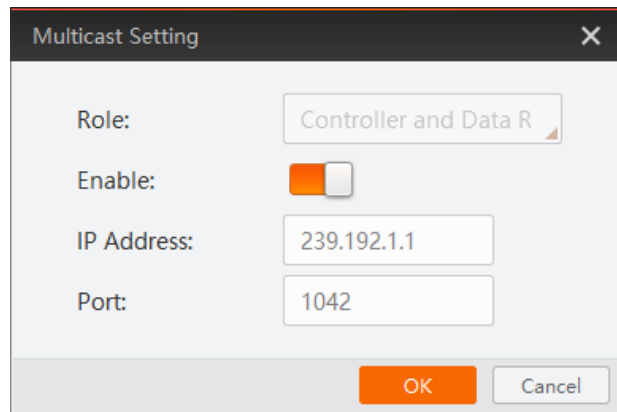
**Figure 13-12 Multicast Settings**

2. Enable the multicast function, and edit the **IP Address** and **Port**.

---

**Note**

- The connected status device can use multicast function in Controller and Data Receiver mode only.
  - The IP address should be class D IP address, and the port ranges from 0 to 65535.
- 



**Figure 13-13 Set Parameters**

3. Click **OK**.

## 13.7 Update Firmware

You can use the MVS Tool Kit to update the device's firmware.



---

**Note**

The MVS Tool Kit is installed by default when you install the MVS client software.

---

## Steps

1. Go to **All** → **Configuration Tool** → **Firmware Upgrade Tool** after running MVS Tool Kit.
2. Click  in **GigE** to enumerate devices.
3. Click  to select firmware upgrade package (dav file).
4. Click **Update** to start updating.

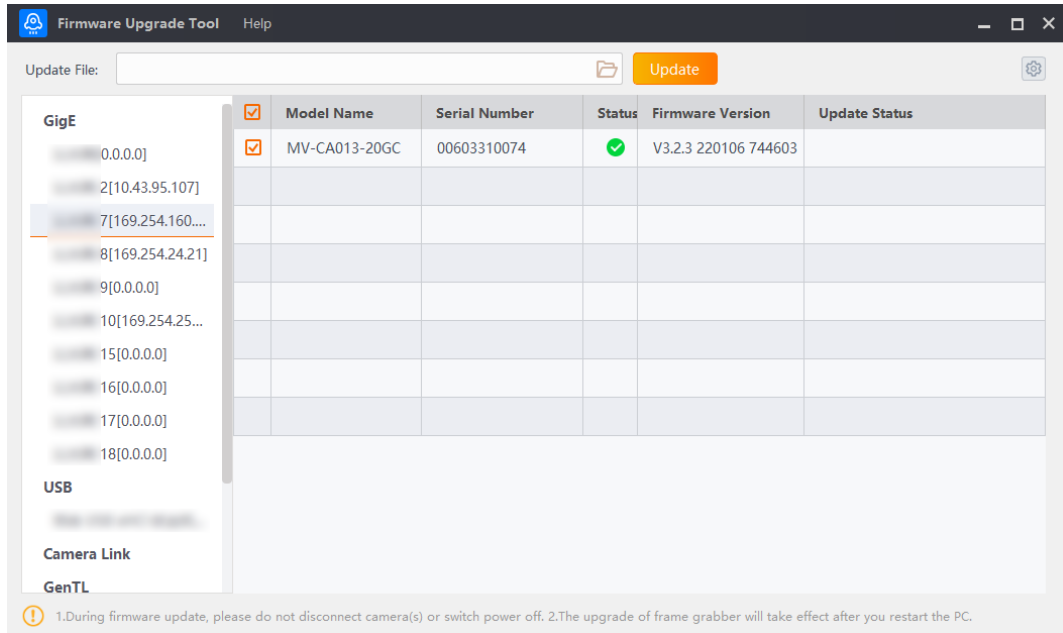


Figure 13-14 Update Firmware

## Note

- The device will reboot automatically after updating the firmware.
- The firmware updating process may take a few minutes, please wait patiently.
- During firmware updating, do not disconnect the device or switch power off.

## 13.8 Encrypt Device via Dongle Tool

## Note

- This function may differ by device models.
- You can contact the technical support to get the dongle tool.

The dongle tool is used to encrypt and decrypt devices for protecting data.

## Steps

1. Run the dongle tool, and click **Enumerate**.
2. Click **Create Random Secret Key** or enter it manually.
3. Click **Write Secret Key**.
4. Enter plaintext that should be no more than 15 characters, and click **Verify**.

The screenshot shows a software interface for encrypting a device via a dongle. It is divided into four steps:

- Step 1 :** A button labeled "Enumerate" is next to a dropdown menu.
- Step 2 : Enter Secret Key**: A text input field is present. Below it is a button "Create Random Secret Key" and a note: "The encryption key is composed of 64 hexadecimal digits, or an English string of 32 characters. The user can manually enter or click Create Encryption Key."
- Step 3**: A button labeled "Write Secret Key" is shown.
- Step 4 : Verify and Decrypt**: A text input field contains "Plaintext1234" and a button labeled "Verify". Below this is a note: "The plaintext is set to the camera, and the camera returns the encrypted one. The encryption tool decrypts the encryption key, and verifies whether the decrypted result is consistent with the plaintext."

**Figure 13-15 Encrypt Device via Dongle Tool**

## Chapter 14 FAQ (Frequently Asked Question)

### 14.1 Why the client software cannot list devices?

#### Reason

- The device is not powered on.
- Incorrect network cable connection.

#### Solution

Check the device's power supply and network connection by observing the device's indicator and network link indicator.

### 14.2 Why device connection fails after the device is listed in the client software?

#### Reason

- The device and the client software are not in the same network segment.
- The device has been connected by other programs.

#### Solution

- Use IP configurator tool to edit the device's IP address to make sure that the device and the client software are in the same network segment.
- Disconnect the device with other programs, and reconnect it to the client software.

### 14.3 Why the live view is black?

#### Reason

- The device's lens aperture is not removed.
- The device exception occurs.

#### Solution

- Remove the device's lens aperture.
- Power off and restart the device.

## 14.4 Why the device cannot be triggered although the live view is normal?

### Reason

- The trigger mode is not enabled or the device is not triggered.
- Incorrect trigger wiring.

### Solution

- Enable the trigger mode and make sure that the selected trigger source matches with the corresponding I/O signal.
- Check if the input of trigger signal and wiring are correct or not.

## 14.5 Why the network changes from GigE Ethernet to Fast Ethernet?

### Reason

The network cable may be damaged.

### Solution

Check the network cable, and replace it if it is damaged.

## 14.6 Why the device is disconnected during operation?

### Reason

- Use the adapter to connect the device.
- Many devices are connected to a switch, resulting in insufficient bandwidth.
- Insufficient power supply causes the device to disconnect.

### Solution

- The device manufactured by our company has high requirements for data transmission, and the quality of adapters on the market is not very good, which cannot guarantee the effective transmission of data. It is not recommended to use adapters to connect the device.
- The device needs a GigE data transmission environment, and each device needs to be guaranteed a GigE transmission environment. If multiple devices are used together, it is recommended to use PCIE independent GigE NIC or a vision controller with multiple connectors.
- It is recommended to use DC power supply. Refer to the device's datasheet for the power supply range.



## Chapter 15 Revision History

**Table 15-1 Revision History**

Version	Document No.	Revision Date	Revision Details
V4.0.0	UD34944B	Sep. 8, 2023	<ul style="list-style-type: none"> <li>• Optimize the structure of the manual.</li> <li>• Add section Cleaning Instruction.</li> <li>• Modify section Overview.</li> <li>• Add section Device Hardware.</li> <li>• Add section Power Supply and Heat Dissipation.</li> <li>• Add section Image Transmission.</li> </ul>
V3.5.5	UD32108B	Mar. 6, 2023	<ul style="list-style-type: none"> <li>• Modify section Appearance.</li> <li>• Modify section I/O Connector and Indicator.</li> <li>• Modify section Client Software Layout.</li> <li>• Add section Set Full Frame Transmission.</li> <li>• Modify section Device Control.</li> <li>• Modify section File Access Control.</li> <li>• Modify section Transport Layer Control.</li> <li>• Modify section Device Parameter Index.</li> </ul>
V3.5.4	UD31188B	Dec. 5, 2022	<ul style="list-style-type: none"> <li>• Add section Set Super Bayer.</li> <li>• Modify section Set Binning.</li> <li>• Modify section Set Gamma Correction.</li> <li>• Modify section Set Sharpness.</li> <li>• Modify section Set Contrast Ratio.</li> <li>• Modify section Set Super Palette Control.</li> <li>• Modify section Set LUT.</li> </ul>
V3.5.3	UD29959B	Sep. 5, 2022	<ul style="list-style-type: none"> <li>• Modify section Safety Instructions.</li> <li>• Add section Set Overlap Mode.</li> <li>• Modify section Set Pixel Format.</li> <li>• Add section Set Sequencer Control and HDR.</li> <li>• Modify section Set Color Transformation Control.</li> <li>• Modify section File Access Control.</li> <li>• Modify section Transfer Control.</li> <li>• Modify section User Set Customization.</li> </ul>
V3.5.1	UD29515B	July 25, 2022	<ul style="list-style-type: none"> <li>• Modify section Appearance.</li> <li>• Modify section I/O Connector and Indicator.</li> </ul>
V3.5.0	UD28667B	May 30, 2022	<ul style="list-style-type: none"> <li>• Modify section Appearance.</li> <li>• Modify section I/O Connector and Indicator.</li> <li>• Modify Section I/O Electrical Features and Wiring.</li> </ul>

## GigE Area Scan Camera User Manual

---

Version	Document No.	Revision Date	Revision Details
			<ul style="list-style-type: none"> <li>● Add Section WDR Mode.</li> <li>● Add Section Sensor Mode</li> </ul>
V3.4.50	UD26223B	Nov. 11, 2021	Modify section I/O Wiring.
V3.4.43	UD24711B	Jul. 12, 2021	<ul style="list-style-type: none"> <li>● Add section Super Palette Control.</li> <li>● Add section Encrypt Device via Dongle Tool.</li> </ul>
V3.4.24	UD22445B	Dec. 24, 2020	Add Section Set Color Adjustment.
V3.4.20	UD21233B	Sep. 27, 2020	<ul style="list-style-type: none"> <li>● Modify Section Client Software Layout.</li> <li>● Modify Section Set Frame Rate.</li> <li>● Add Section Set Image Compression Mode.</li> <li>● Add Section Set Digital Noise Reduction.</li> <li>● Modify Section Hue.</li> <li>● Modify Section Saturation.</li> <li>● Modify Section Device Control.</li> <li>● Add Section Transfer Control.</li> </ul>
V3.4.9	UD19137B	April 8, 2020	<ul style="list-style-type: none"> <li>● Add Section Overview.</li> <li>● Modify Section Appearance.</li> <li>● Modify Section Client Software Layout.</li> <li>● Add Section Sensor Shutter Mode.</li> <li>● Modify Section Set Pixel Format.</li> <li>● Modify Section Set Test Pattern.</li> <li>● Add Section Set Shading Correction.</li> <li>● Modify Section Transport Layer Control.</li> </ul>
V1.0.1	UD15735B	Jul. 24, 2019	<ul style="list-style-type: none"> <li>● Add Section Set Anyway Trigger.</li> <li>● Modify Section Set Action Command.</li> <li>● Add Section Set Color Transformation Control.</li> </ul>
V1.0.0	UD12911B	Jan. 9, 2019	Original version.

## Appendix A Device Parameter Index

Here list all parameters of the device mentioned in different sections of this user manual. You can quickly locate parameters in different sections by viewing tables below.

### A.1 Device Control

Table Appendix A-1 Device Control

Parameters	Section
Device Type	Section Device Control
Device Scan Type	
Device Vendor Name	
Device Model Name	
Device Manufacturer Info.	
Device Version	
Device Firmware Version	
Device Serial Number	
Device ID	
Device User ID	
Device Uptime (s)	
Board Device Type	
Device Connection Selector	
Device Type	
Device Scan Type	
Device Vendor Name	
Device Model Name	
Device Manufacturer Info.	
Device Version	
Device Firmware Version	
Device Serial Number	
Device ID	

Parameters	Section
Device User ID	
Device Uptime (s)	
Board Device Type	
Device Connection Selector	
Device Connection Speed (Mbps)	
Device Link Selector	
Device Link Speed (Mbps)	
Device Link Connection Count	
Device Link Heartbeat Mode	
Device Stream Channel Count	
Device Stream Channel Selector	
Device Stream Channel Type	
Device Stream Channel Link	
Device Stream Channel Endianness	
Device Stream Channel Packet Size (B)	
Device Event Channel Count	
Device Character Set	
Device Reset	
Device Temperature Selector	
Device Temperature	
Relative Humidity	
Device Fan Enable	
TEC Enable	
TEC Temperature	
TEC Voltage	
Find Me	
Device Max Throughput (Kbps)	
Device PJ Number	
HB Abnormal Monitor	
HB Version	

## A.2 Image Format Control

Table Appendix A-2 Image Format Control

Parameters	Section
Width Max	Section View Resolution and Crop Image
Height Max	
Region Selector	
Region Destination	
Width	
Height	
Offset X	
Offset Y	
Reverse X	Section Set Image Reverse
Reverse Y	
ADC Bit Depth	Section Set Pixel Format
Pixel Format	
Super Bayer Enable	
Pixel Size	
Image Compression Mode	Section Set Image Compression Mode
High Bandwidth Mode	
Test Pattern Generator Selector	Section Set Test Pattern
Test Pattern	
Binning Mode	Section Set Binning
Binning Selector	
Binning Horizontal	
Binning Vertical	
Decimation Horizontal	Section Set Decimation
Decimation Vertical	
Embedded Image Info Selector	Section Embed Information into Image
Frame Spec Info	

## A.3 Acquisition Control

Table Appendix A-3 Acquisition Control

Parameters	Section
Acquisition Mode	Section Set Acquisition Mode
Acquisition Start	
Acquisition Stop	
Acquisition Burst Frame Count	Section Set Frame Rate
Acquisition Frame Rate (Fps)	
Acquisition Frame Rate Control Enable	
Resulting Frame Rate (Fps)	
Reference Frame Rate	Section Non-Overlap Exposure and Overlap Exposure
Overlap Mode	
Trigger Selector	Section Trigger Input
Trigger Mode	
Trigger Software	
Trigger Source	
Trigger Activation	
Trigger Delay ( $\mu$ s)	
Trigger Cache Enable	
Sensor Shutter Mode	Section Rolling Shutter
Exposure Time Mode	Section Set Exposure Mode
Exposure Mode	
Exposure Time ( $\mu$ s)	
Exposure Auto	
Auto Exposure Time Lower Limit ( $\mu$ s)	
Auto Exposure Time Upper Limit ( $\mu$ s)	Section Set WDR Mode
WDR Mode	
WDR Level	

Parameters	Section
HDR Enable	Section Set HDR
HDR Selector	
HDR Shutter ( $\mu$ s)	
HDR Gain	
Full Frame Transmission	Set Full Frame Transmission

## A.4 Analog Control

**Table Appendix A-4 Analog Control**

Parameters	Section
Preamplifier Gain	Section Set Gain
Gain (dB)	
Gain Auto	
Auto Gain Lower Limit (dB)	
Auto Gain Upper Limit (dB)	
Digital Shift	
Digital Shift Enable	
Sensor Mode	Section Set Sensor Mode
Brightness	Section Set Brightness
Black Level	Section Set Black Level
Black Level Enable	
Balance White Auto	Section Set White Balance
AWB Color Temperature Mode	
Balance Ratio Selector	
Balance Ratio	
Gamma	Section Set Gamma Correction
Gamma Selector	
Gamma Enable	
Sharpness	Section Set Sharpness
Sharpness Enable	

Parameters	Section
Digital Noise Reduction Mode	Section Set Digital Noise Reduction
Denoise Strength	
Noise Correct	
Channel Correct Mode	Section Set Channel Correct Mode
Fan Open Threshold	Section Set Cooling Fan
Contrast Ratio	Section Set Contrast Ratio
Contrast Ratio Enable	
Auto Function AOI Selector	Section Set AOI
Auto Function AOI Width	
Auto Function AOI Height	
Auto Function AOI Offset X	
Auto Function AOI Offset Y	
Auto Function AOI Usage Intensity	
Auto Function AOI Usage White Balance	

## A.5 Color Transformation Control

**Table Appendix A-5 Color Transformation Control**

Parameters	Section
CCM Enable	Section Set Color Transformation Control
Color Transformation Selector	
Color Transformation Enable	
Color Transformation Value Selector	
Color Transformation Value	
Hue	Section Set Hue
Hue Enable	
Saturation	Section Set Saturation
Saturation Enable	



## A.6 Super Palette Control

Table Appendix A-6 Super Palette Control

Parameters	Section
Super Palette Enable	Section Set Super Palette Control
Super Palette Selector	
Super Palette Hue	
Super Palette Saturation	

## A.7 LUT Control

Table Appendix A-7 LUT Control

Parameters	Section
LUT Selector	Section Set LUT
LUT Enable	
LUT Index	
LUT Value	
LUT Save	

## A.8 Shading Correction

Table Appendix A-8 Shading Correction

Parameters	Section
Shading Selector	Section Set Shading Correction
Activate Shading	
NUC Enable	
FPNC Enable	
PRNUC Enable	
LSC Enable	

## A.9 Digital IO Control

Table Appendix A-9 Digital IO Control

Parameters	Section
Line Selector	Section Trigger Output
Line Mode	
Line Inverter	
Line Status	
Line Status All	
Line Debouncer Time ( $\mu\text{s}$ )	
Line Source	
Strobe Enable	
Strobe Line Duration ( $\mu\text{s}$ )	
Strobe Line Delay ( $\mu\text{s}$ )	
Strobe Line Pre Delay ( $\mu\text{s}$ )	

## A.10 Action Control

Table Appendix A-10 Action Control

Parameters	Section
Action Unconditional Mode	Section Set Action Command
Action Device Key	
Action Queue Size	
Action Selector	
Action Group Mask	
Action Group Key	

## A.11 Counter and Timer Control

Table Appendix A-11 Counter and Timer Control

Parameters	Section
------------	---------

Parameters	Section
Counter Selector	Section Set Trigger Source
Counter Event Source	
Counter Reset Source	
Counter Reset	
Counter Value	
Counter Current Value	

## A.12 File Access Control

**Table Appendix A-12 File Access Control**

Parameters	Section
File Selector	Section File Access Control
File Operation Selector	
File Operation Execute	
File Open Mode	
File Operation Status	
File Operation Result	
File Size(B)	

## A.13 Sequencer Control

**Table Appendix A-13 Sequencer Control**

Parameters	Section
Sequencer Mode	Section Set Sequencer
Sequencer Configuration Mode	
Sequencer Feature Selector	
Sequencer Feature Enable	
Sequencer Restart	
Sequencer Set Total Number	
Sequencer Set Selector	

Parameters	Section
Sequencer Set Active	
Sequencer Set Load	
Sequencer Set Save	

## A.14 Event Control

Table Appendix A-14 Event Control

Parameters	Section
Event Selector	Section Event Control
Event Notification	

## A.15 Chunk Data Control

Table Appendix A-15 Chunk Data Control

Parameters	Section
Chunk Mode Active	Section Chunk Settings
Chunk Selector	
Chunk Enable	

## A.16 Transport Layer Control

Table Appendix A-16 Transport Layer Control

Parameters	Section
Payload Size(B)	
GEV Version Major	
GEV Version Minor	
GEV Device Mode Is Big Endian	
GEV Device Mode Character Set	
GEV Interface Selector	
GEV MAC Address	

Parameters	Section
GEV Supported Option Selector	Section Transport Later Control
GEV Supported Option	
GEV Current IP Configuration LLA	
GEV Current IP Configuration DHCP	
GEV Current IP Configuration Persistent IP	
GEV PAUSE Frame Reception	
GEV Current IP Address	
GEV Current Subnet Mask	
GEV Current Default Gateway	
GEV First URL	
GEV Second URL	
GEV Number Of Interfaces	
GEV Persistent IP Address	
GEV Persistent Subnet Mask	
GEV Persistent Default Gateway	
GEV Link Speed	
GEV Message Channel Count	
GEV Stream Channel Count	
GEV Heartbeat Timeout(ms)	
GEV Heartbeat Disable	
GEV Timestamp Tick Frequency(Hz)	
Timestamp Control Latch	
Timestamp Control Reset	
Timestamp Control Latch Reset	
Timestamp Value	
GEV CCP	
GEV MCP Host Port	
GEV MCDA	
GEV MCTT(ms)	
GEV MCRC	

Parameters	Section
GEV MCSP	
GEV Stream Channel Selector	
GEV SCP Interface Index	
GEV SCP Host Port	
GEV SCP Direction	
GEV SCPS Fire Test Packet	
GEV SCPS Do Not Fragment	
GEV SCPS Big Endian	
GEV SCPS Packet Size(B)	
GEV SCPD	
GEV SCDA	
GEV SCSP	
GEV IEEE 1588	
Gev IEEE 1588 Slave Only	
GEV IEEE 1588 Status	
GEV GVSP Extended ID Mode	

## A.17 Transfer Control

**Table Appendix A-17 Transfer Control**

Parameters	Section
Transfer Control Selector	Section Transfer Control
Transfer Passive Enable	
Transfer Operation Mode	
Transfer Start	
Transfer Selector	
Transfer Control Selector	
Transfer Queue Max Block Count	
Transfer Queue Current Block Count	
Transfer Queue Over Flow Count	

Parameters	Section
Transfer Queue Mode	

## A.18 User Set Control

Table Appendix A-18 User Set Control

Parameters	Section
User Set Current	Section User Set Customization
User Set Selector	
User Set Load	
User Set Load Status	
User Set Save	
User Set Default	



***HIKROBOT***

SHAPE OUR FUTURE INTELLIGENTLY

**Hangzhou Hikrobot Technology Co.,Ltd.**

E-mail: [global.support@hikrobotics.com](mailto:global.support@hikrobotics.com)

Website: <https://en.hikrobotics.com/>

UD34944B